

小学 新1年

学習準備シートその2

もんだい

来々々の来



() ねん () くみ () ばん
なまえ ()

1

こえに だしてみよう
 ◎おうちの ひとなどと いっしょに やってみましょう。

いちねん なまえ

えをみて しつもんに こたえましょう。

(5)	(4)	(3)	(2)	(1)	
					え
<p>あさ せんせいに あいさつを しています。 なんと いっぺい いるかな。</p>	<p>なにを しているのかな。</p>	<p>なにを しているのかな。</p>	<p>なんの いきもの かな。</p>	<p>なんの どうぶつ かな。</p>	しつもん



2

かいて みよう

◎おうちのひとなどと いっしょに やってみましょう。

いちねん なまえ

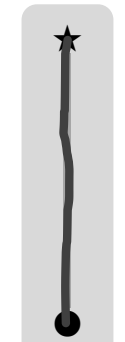
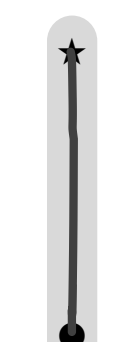
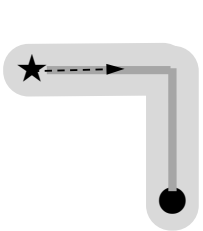
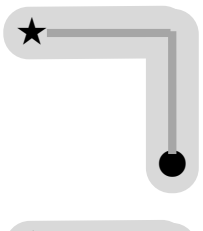
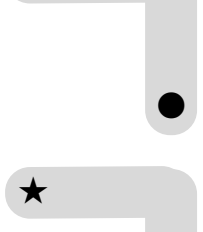
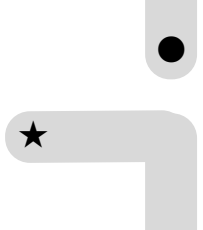
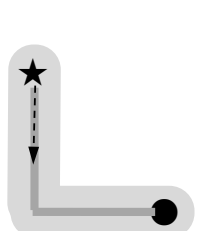
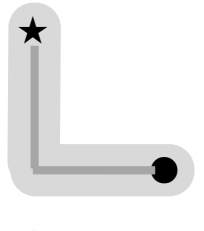
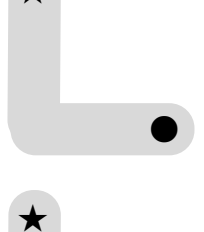
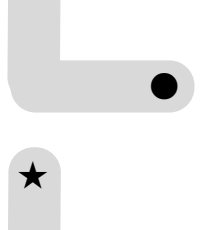
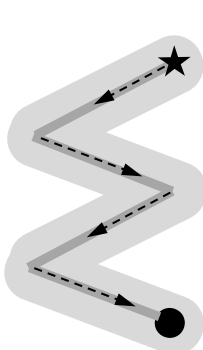
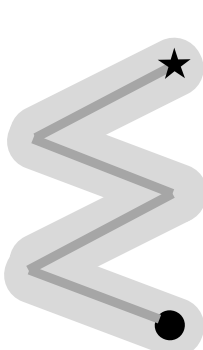
おてほんのように ★から ●に むかって、
 ように かきましよう。

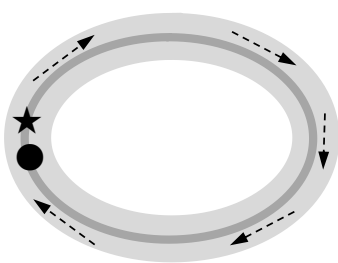
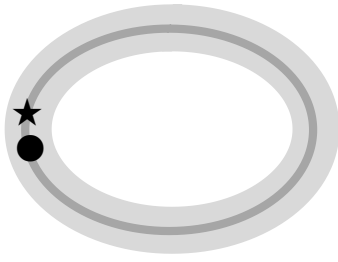
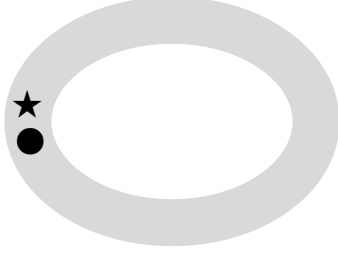
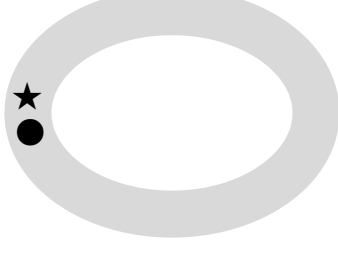
おてほん	(1)	(2)	(3)	(4)
  	   	   	  	   

3

かきくけこを みつけよう

◎おうちのひとなどと いっしょに やってみましょう。

いちねん なまえ

しつもんに こたえましょう。

(5)	(4)	(3)	(2)	(1)	
こ	け	く	き	か	
<p>こではじまる ことばを みつけよう。</p> <p>いくつ みつかる かな。</p>	<p>けではじまる ことばを みつけよう。</p> <p>いくつ みつかる かな。</p>	<p>くではじまる ことばを みつけよう。</p> <p>いくつ みつかる かな。</p>	<p>きではじまる ことばを みつけよう。</p> <p>いくつ みつかる かな。</p>	<p>かではじまる ことばを みつけよう。</p> <p>いくつ みつかる かな。</p>	しつもん
<ul style="list-style-type: none"> ●  ●  	<ul style="list-style-type: none"> ●  ●  ●  ●  	<ul style="list-style-type: none"> ●  ●  	<ul style="list-style-type: none"> ●  ●  	<ul style="list-style-type: none"> ●  ●  	



4

かいて みよう

◎おうちのひとなどと いっしょに やってみましょう。

いちねん なまえ

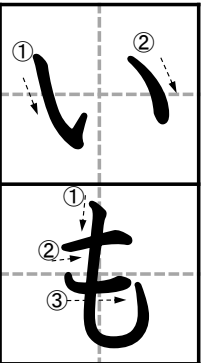
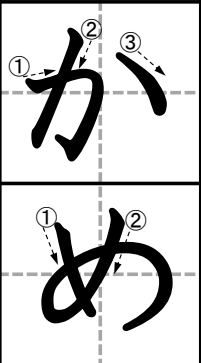
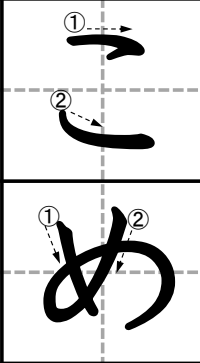
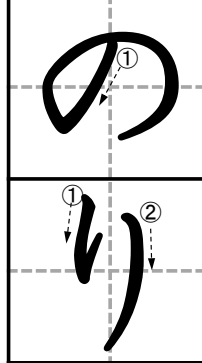
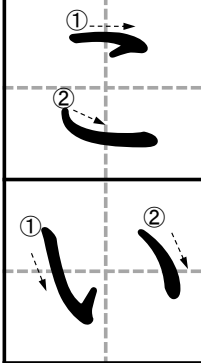
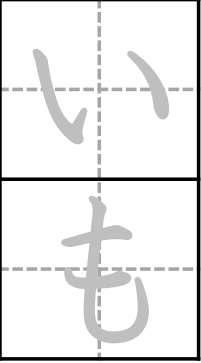
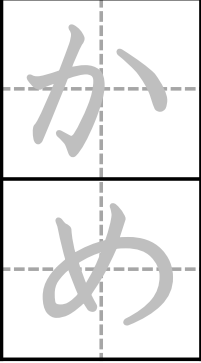
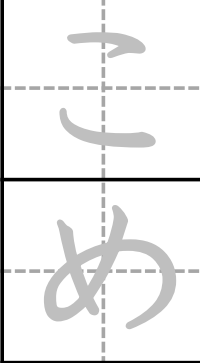
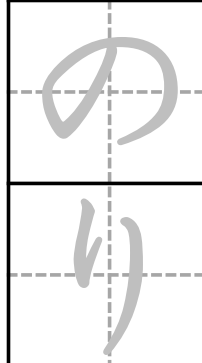
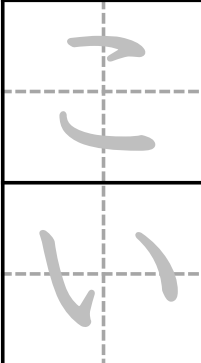
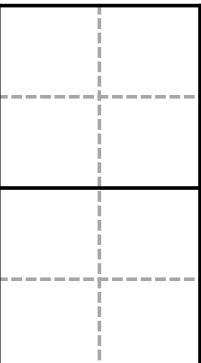
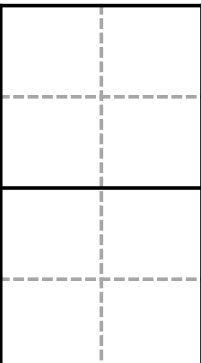
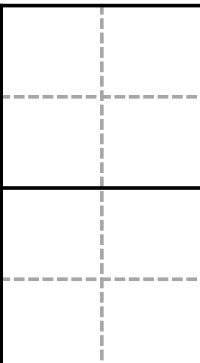
おてほんをみて ひらがなをかいて みましょう。

(5)	(4)	(3)	(2)	(1)	
					<p>おてほん</p>
					<p>なぞりましょう</p>
					<p>かいてみましょう</p>

がくしゅつじゅんびシート ～みらいのいっぽ～

5

じぶんのことをしってもらおう
 ◎おうちのひとなどと いっしょに やってみましょう。

いちねん なまえ

おてほんとおなじように じぶんのことを はなして みましょう。

おてほん

はなして みましょう

わたしの なまえは
 ふくおか みらい です。



わたし(ぼく)の なまえは

です。

すきな たべものは
 いちご です。



すきな たべものは

です。

すきな どうぶつは
 いぬ です。



すきな どうぶつは

です。

すきな あそびは
 おにごっこ です。



すきな あそびは

です。

(5) はる なつ あき ふゆの
 なかで すきな きせつは
 なつです。



はる なつ あき ふゆの

なかで すきな きせつは

です。

6

さしすせそを みつけよう

◎おうちのひとなどと いっしょに やってみましょう。

いちねん なまえ

しつもん に こたえましょう。

(5)	(4)	(3)	(2)	(1)	
そ	せ	す	し	さ	
<p>そで はじまる ことばを みつけよう。 いくつ みつかる かな。</p>	<p>せで はじまる ことばを みつけよう。 いくつ みつかる かな。</p>	<p>すで はじまる ことばを みつけよう。 いくつ みつかる かな。</p>	<p>しで はじまる ことばを みつけよう。 いくつ みつかる かな。</p>	<p>さで はじまる ことばを みつけよう。 いくつ みつかる かな。</p>	しつもん
<p>...</p> 	<p>...</p> 	<p>...</p> 	<p>...</p> 	<p>...</p> 	

7

かいて みよう

◎おうちのひとなどと いっしょに やってみましょう。

いちねん なまえ

おてほんをみて ひらがなをかいて みましょう。

(5)	(4)	(3)	(2)	(1)	
					おてほん
					なぞりましょう
					かいてみましょう

8

たちつてとき みつけよう

◎おうちのひとなどと いっしょに やってみましょう。

いちねん なまえ

しつもんに こたえましょう。

(5)	(4)	(3)	(2)	(1)	
と	て	つ	ち	た	
<p>とではじまる ことばを みつけよう。</p> <p>いくつ みつかる かな。</p>	<p>てではじまる ことばを みつけよう。</p> <p>いくつ みつかる かな。</p>	<p>つではじまる ことばを みつけよう。</p> <p>いくつ みつかる かな。</p>	<p>ちではじまる ことばを みつけよう。</p> <p>いくつ みつかる かな。</p>	<p>たではじまる ことばを みつけよう。</p> <p>いくつ みつかる かな。</p>	しつもん
<ul style="list-style-type: none"> •  •  • 	<ul style="list-style-type: none"> •  •  • 	<ul style="list-style-type: none"> •  •  • 	<ul style="list-style-type: none"> •  •  • 	<ul style="list-style-type: none"> •  •  • 	

こんなとき なんて いおうかな
 ◎おうちの ひとなどと いっしょに やってみましょう。

いちねん なまえ

こんなとき なんと いえば よいか かんがえて はなして みましょう。

こんなとき

なんと いえば よいかな

(1) おうちに かえって きたとき

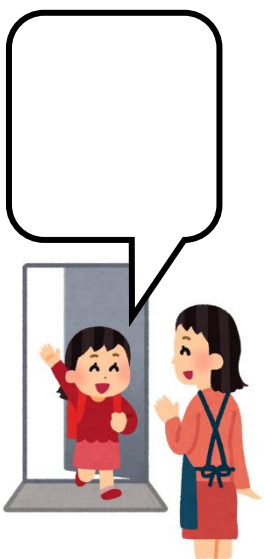

(2) おれいを いうとき

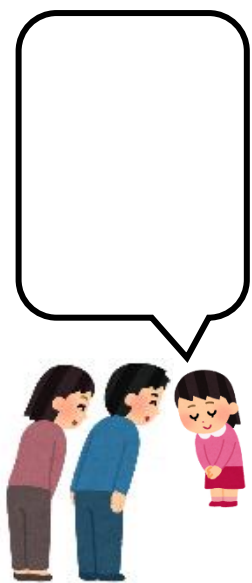

(3) あやまるとき

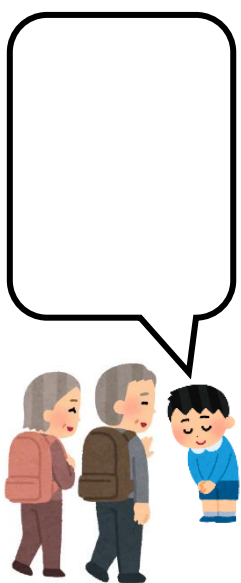

(4) おひるに あいさつ するとき

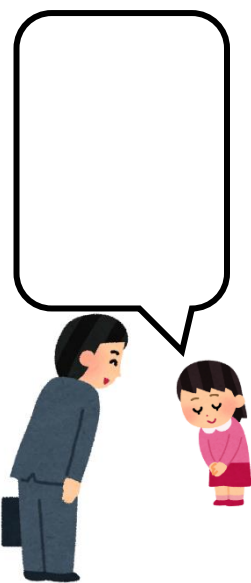

(5) ともだちが こまっているとき

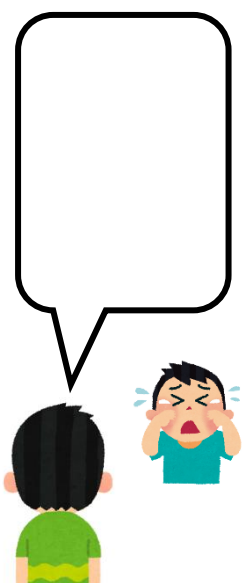

I なかまさがし

いちねん なまえ

◎おうちの ひとなどと いっしょに やってみましょう。

おなじ なかまを せんで かこもう

れい

りんご

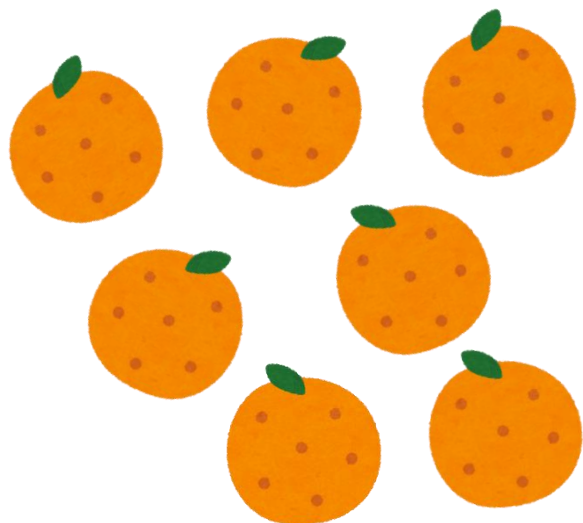
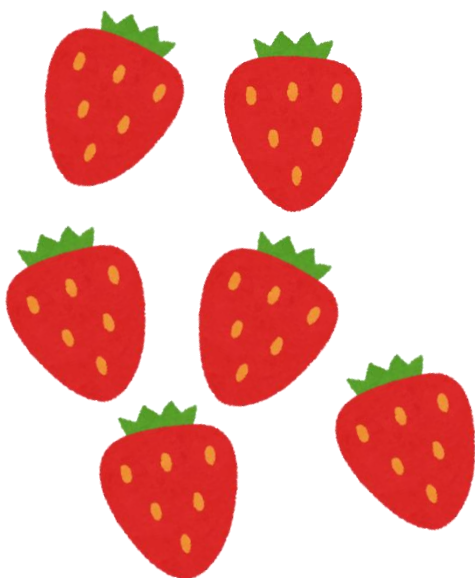
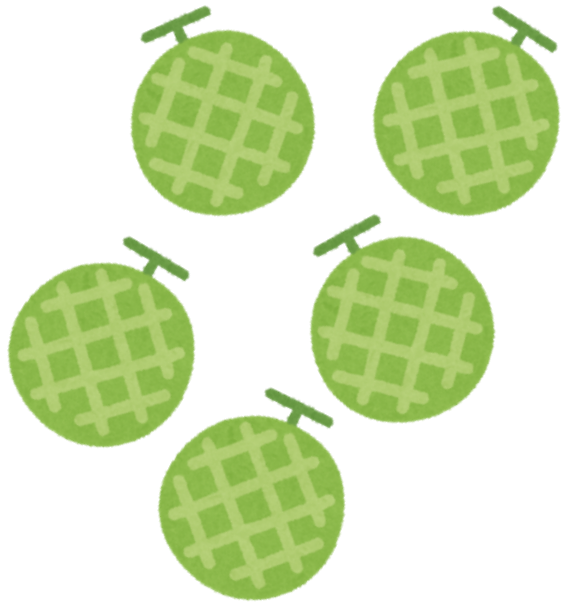
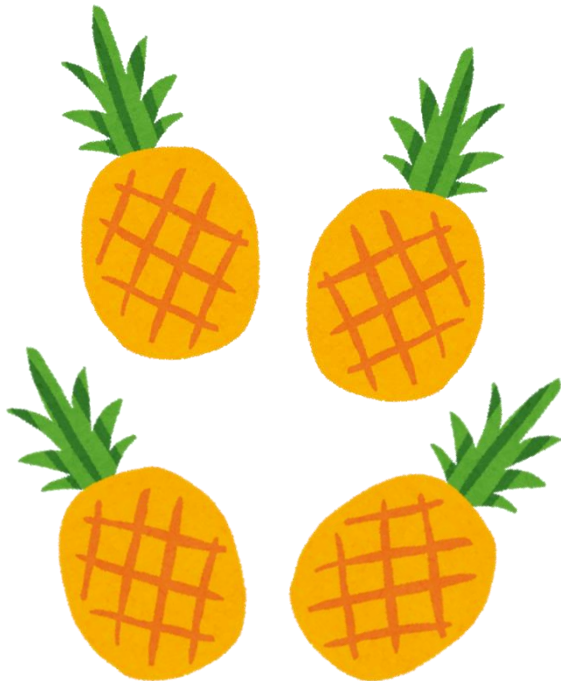
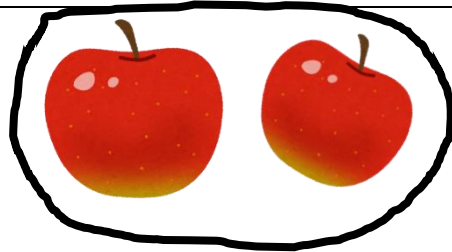

がくしゅう じゅんぴ シート ~みらいへの いっぽ~

II どちらが ながい

いちねん なまえ

◎おうちの ひとなどと いっしょに やってみましょう。

どちらが おおいかな

せんで むすぼう

れい

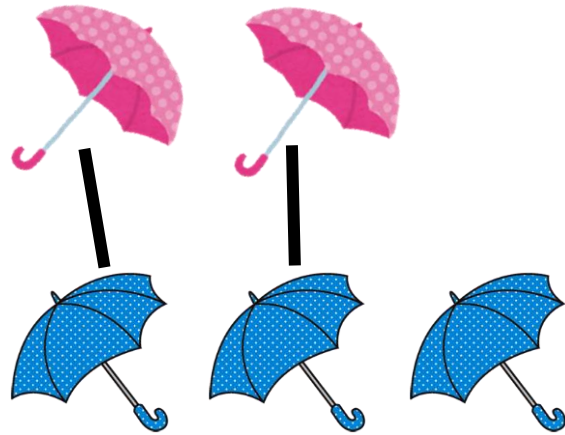

Ⅲ おなじ かず

いちねん なまえ

◎おうちの ひとなどと いっしょに やってみましょう。

おなじ かずだけ いろを ぬろう

れい

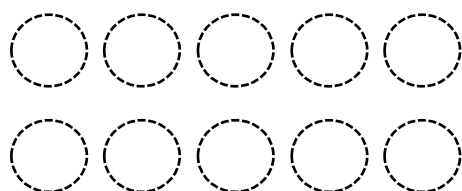
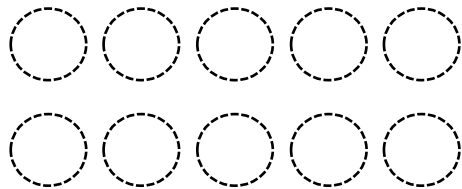
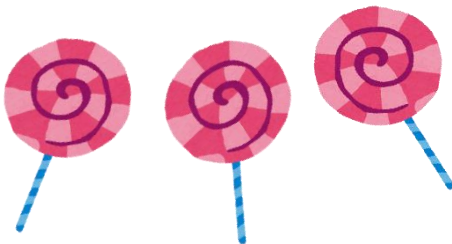
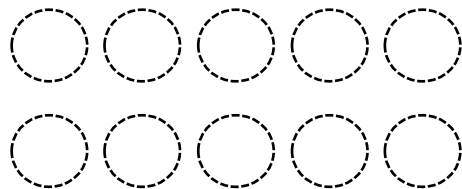
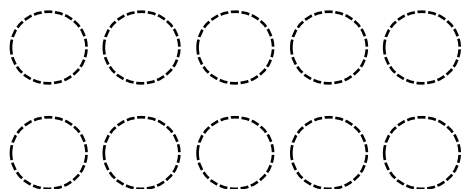
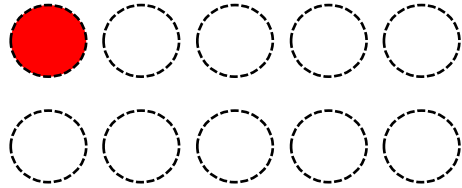

Ⅲ おなじ かず

いちねん なまえ

◎おうちの ひとなどと いっしょに やってみましょう。

おなじ かずだけ いろを ぬろう

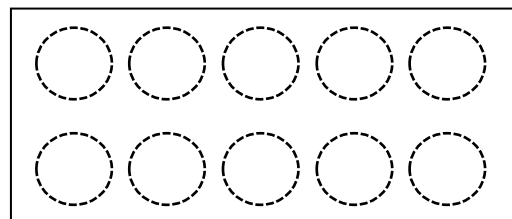
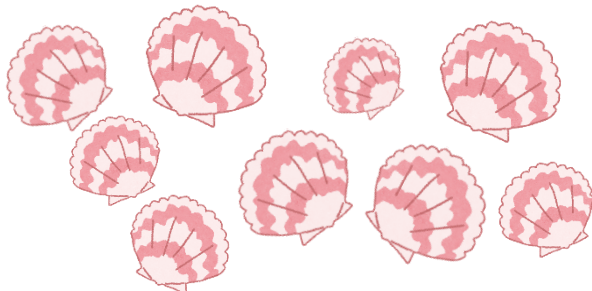
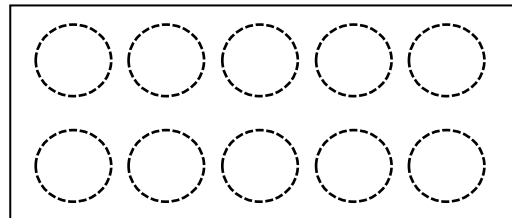
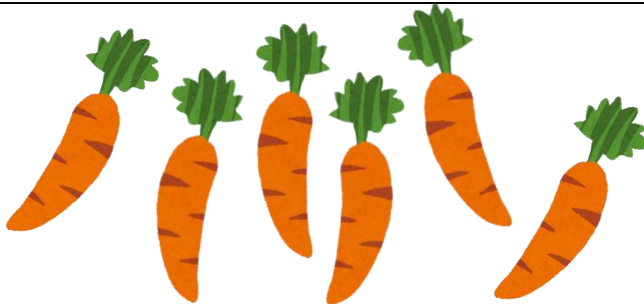
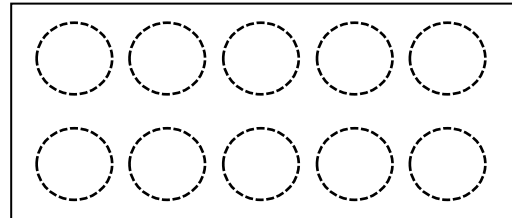
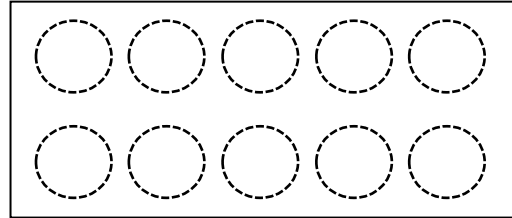
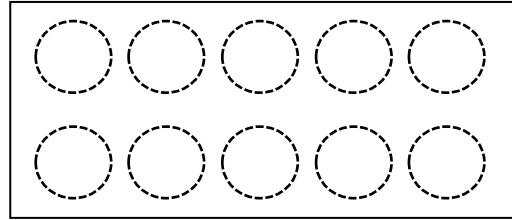
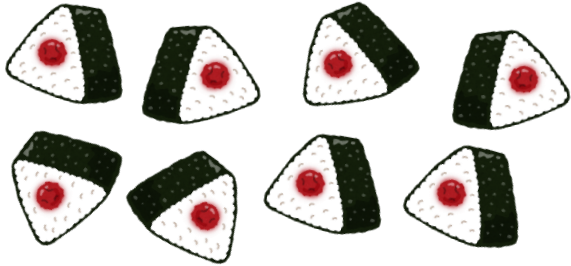

がくしゅう じゅんぴ シート ~みらいへの いっぽ~

IV おなじ ばしょ

いちねん なまえ

◎おうちの ひとなどと いっしょに やってみましょう。

おなじ ばしょに いろを ぬろう

れい

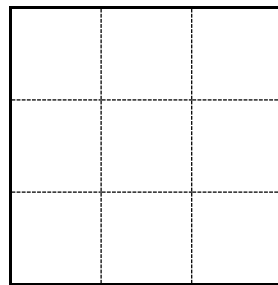
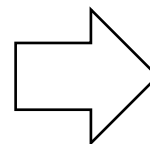
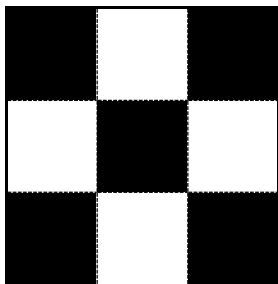
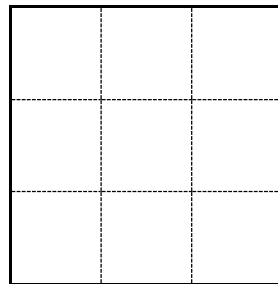
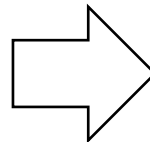
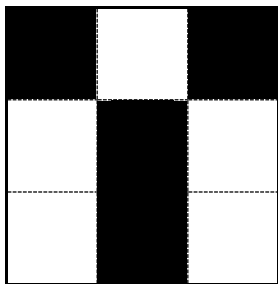
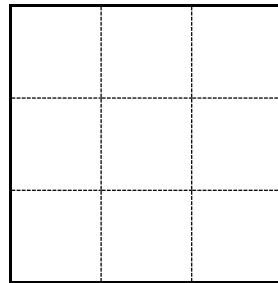
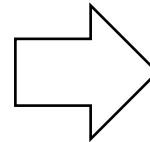
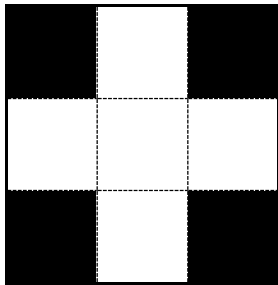
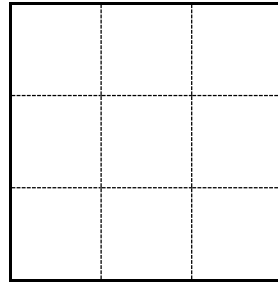
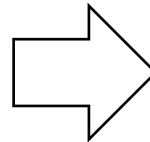
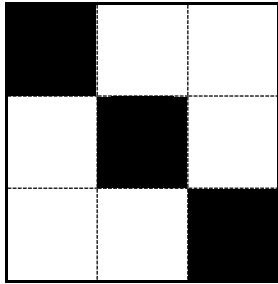
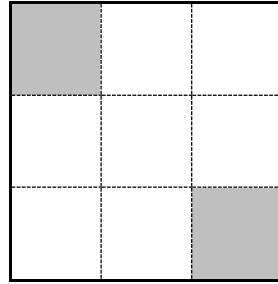
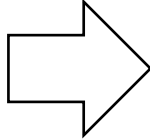
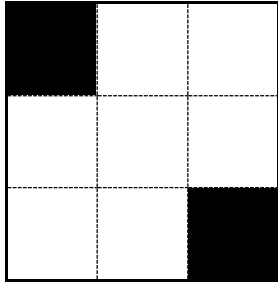

がくしゅう じゅんぴ シート ~みらいへの いっぽ~

V おなじ かたち

いちねん なまえ

◎おうちの ひとなどと いっしょに やってみましょう。

おなじ かたちを さがそう

れい

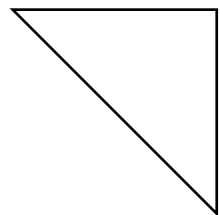
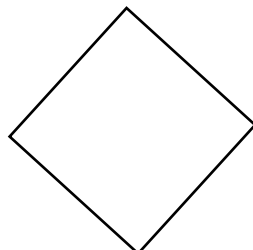
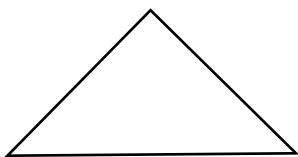
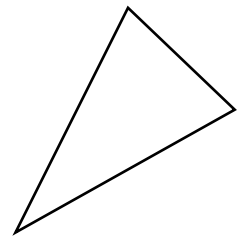
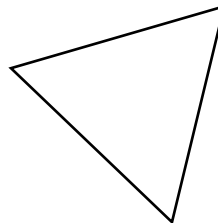
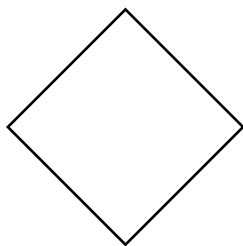
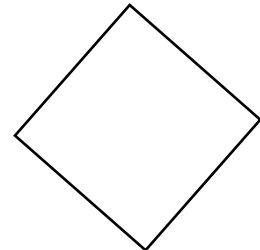
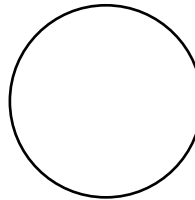
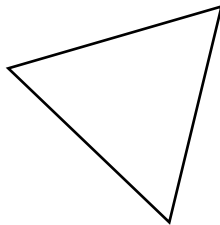
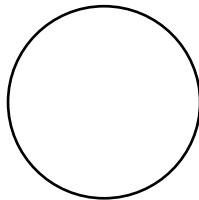
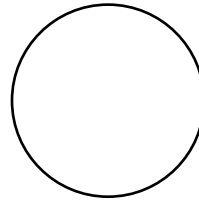
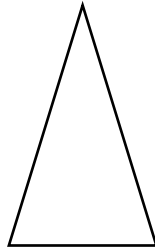
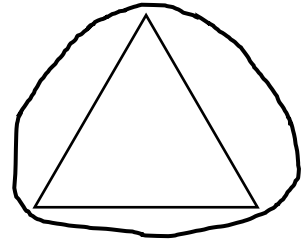
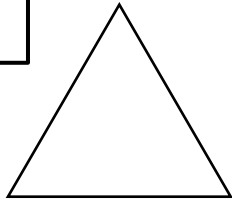

がくしゅう じゅんぴ シート ~みらいへの いっぽ~

I おなじ かず

いちねん なまえ

◎おうちの ひとなどと いっしょに やってみましょう。

おなじ かず どうしを せんで むすぼう

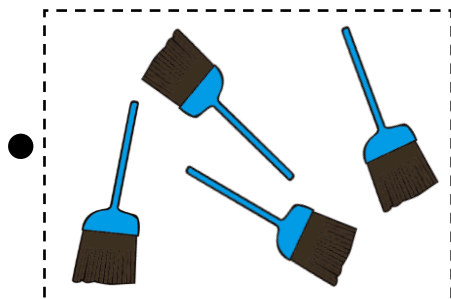
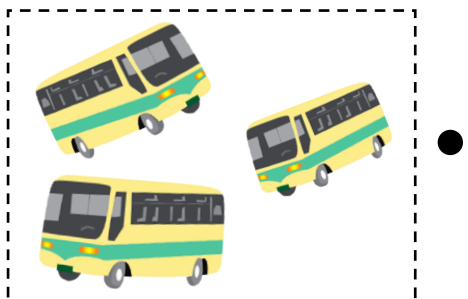
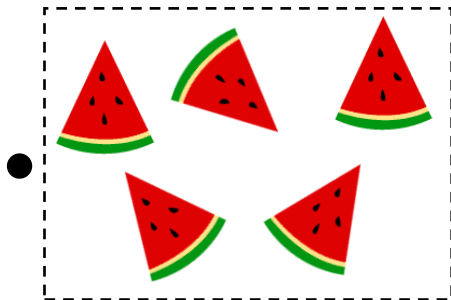
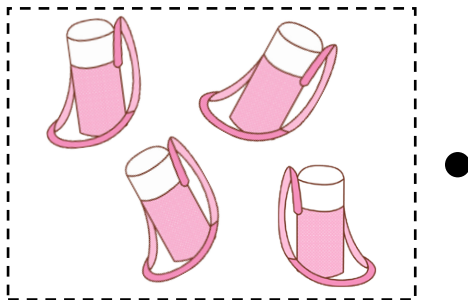
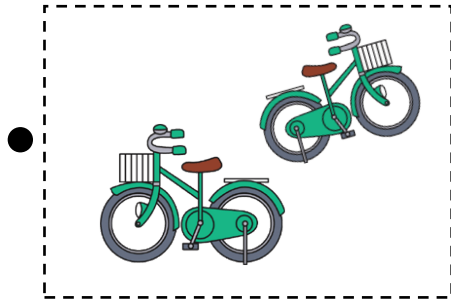
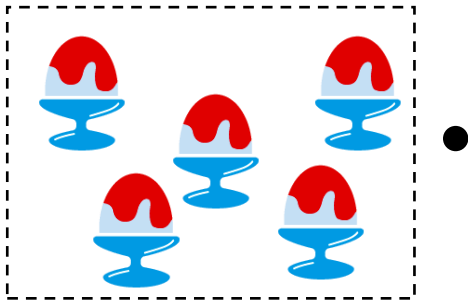
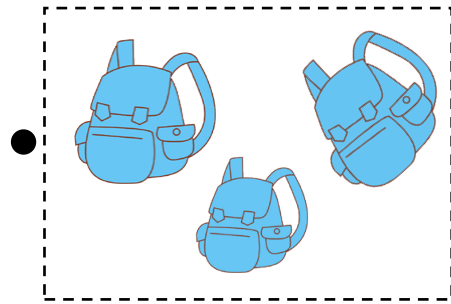
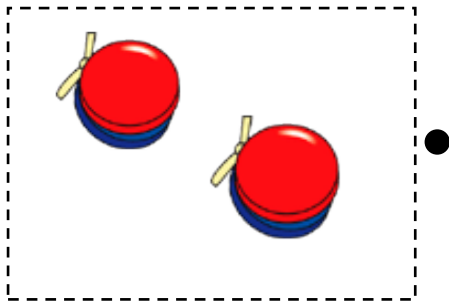

II おなじ かず

いちねん なまえ

◎おうちの ひとなどと いっしょに やってみましょう。

おなじ かず どうしを せんで むすぼう

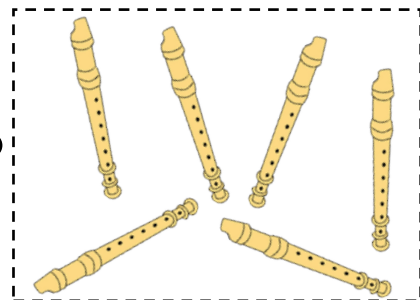
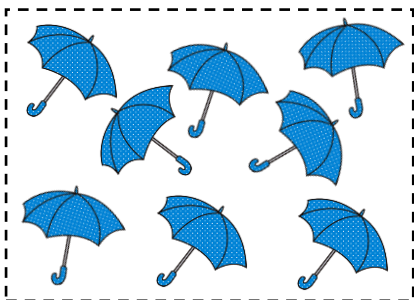
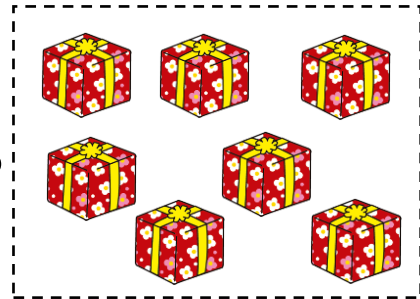
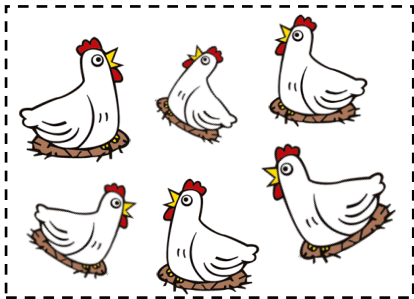
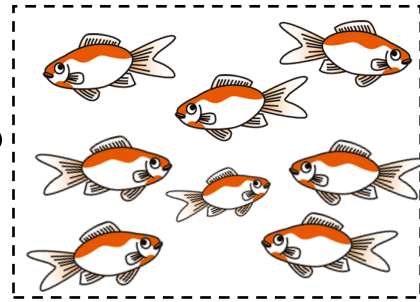
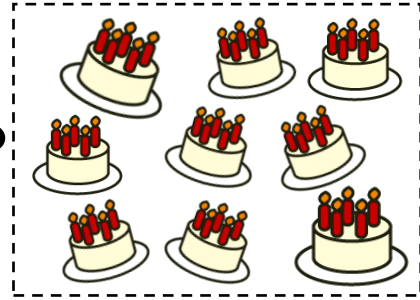

Ⅲ 10までの かず

いちねん なまえ

◎おうちの ひとなどと いっしょに やってみましょう。

すうじを よんで かいてみよう

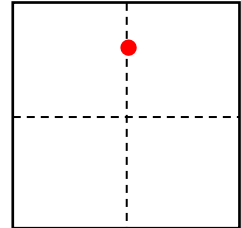
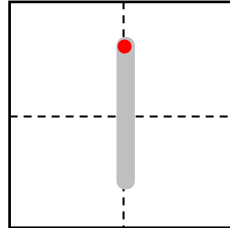
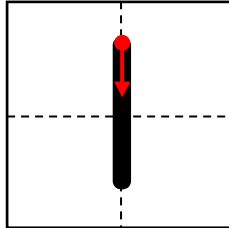
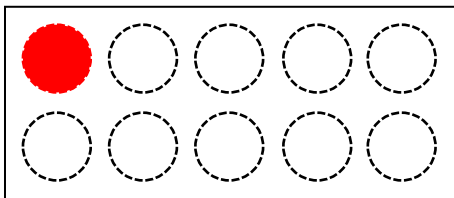

いち

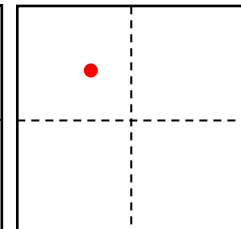
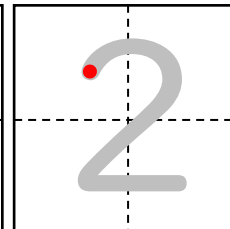
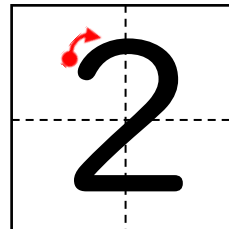
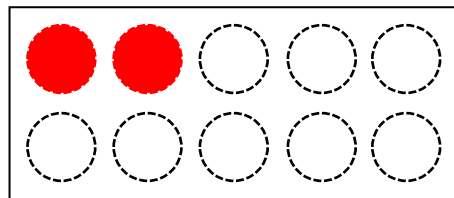

に

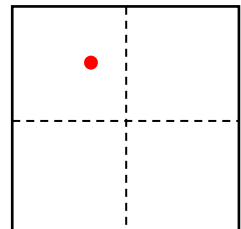
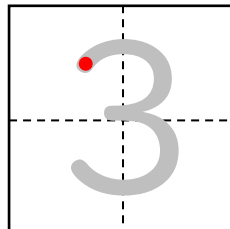
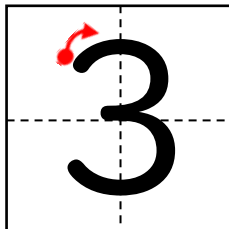
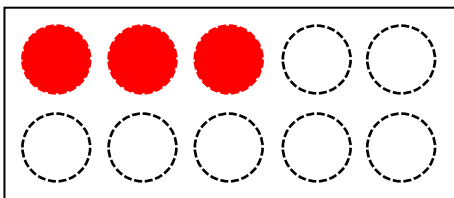

さん

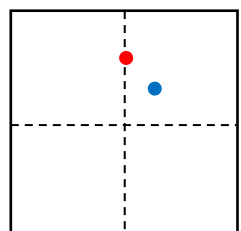
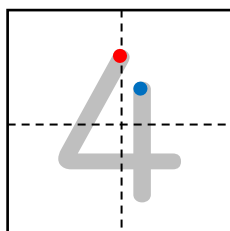
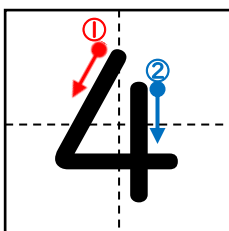
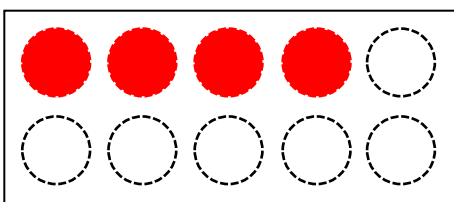

し

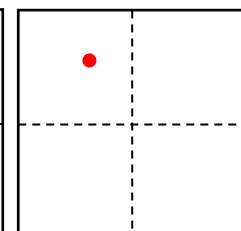
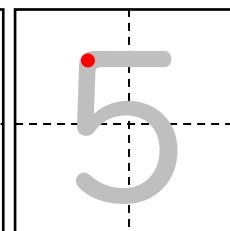
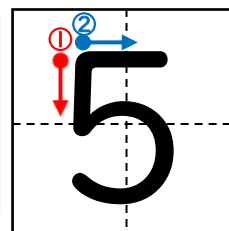
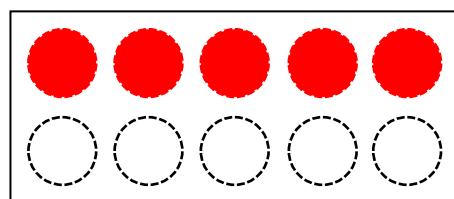

ご

IV 10までの かず

いちねん なまえ

◎おうちの ひとなどと いっしょに やってみましょう。

すうじを よんで かいてみよう

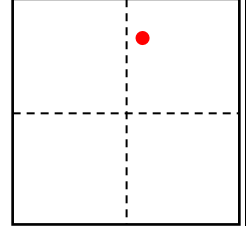
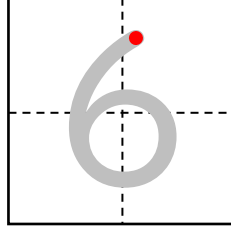
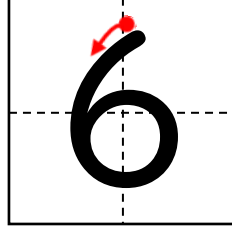
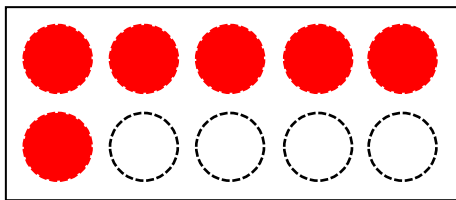

ろく

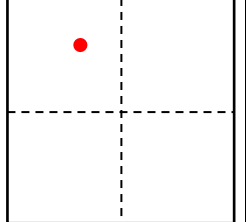
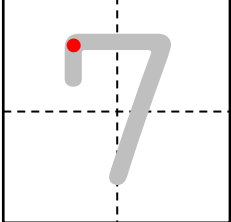
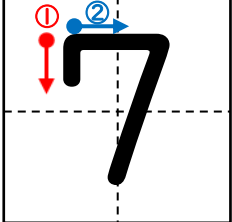
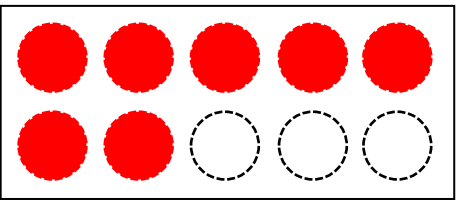

しち(なな)

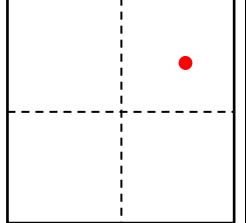
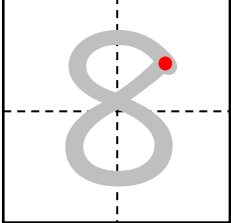
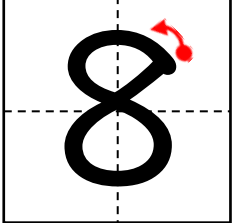
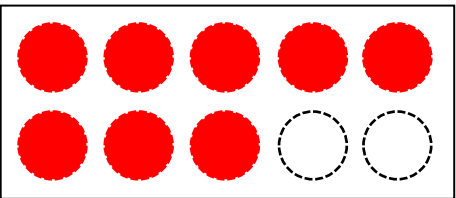

はち

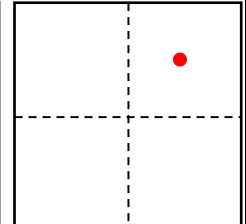
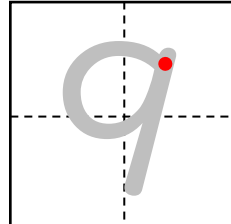
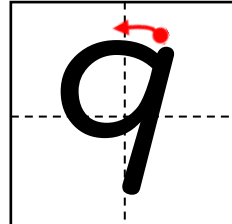
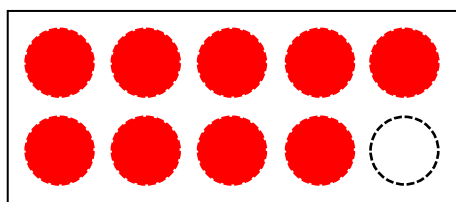

く(きゅう)

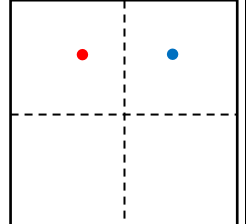
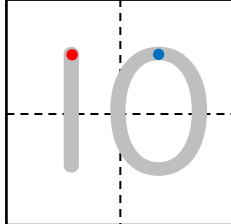
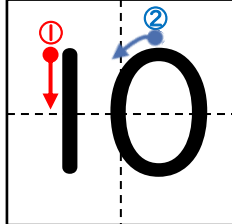
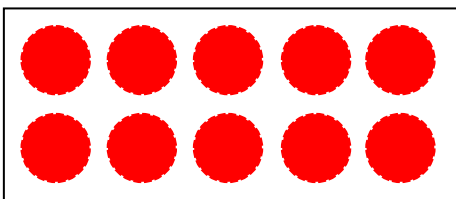

じゅう

がくしゅう じゅんぴ シート ~みらいへの いっぽ~

V おなじ ばしょ

いちねん なまえ

◎おうちの ひとなどと いっしょに やってみましょう。

おなじ ばしょに いろを ぬろう

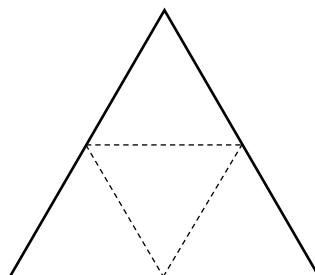
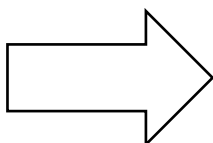
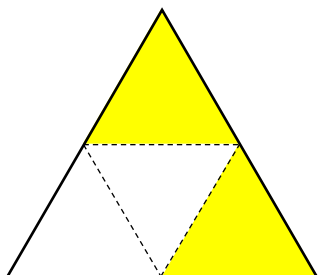
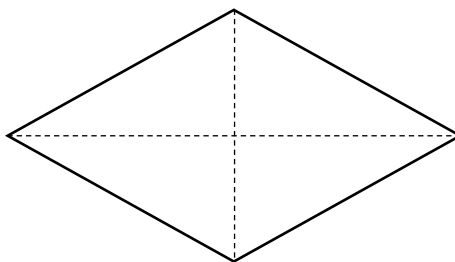
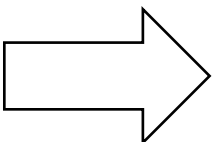
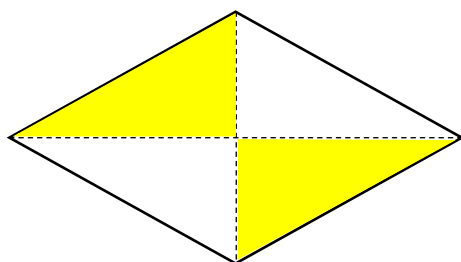
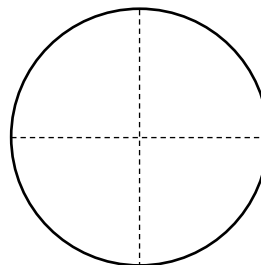
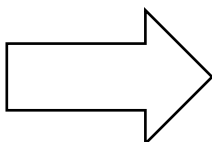
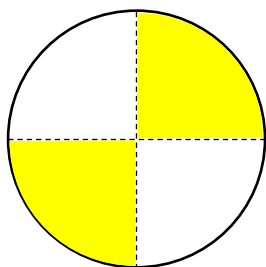
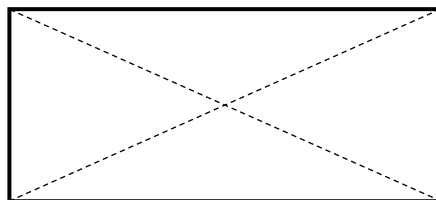
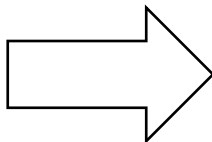
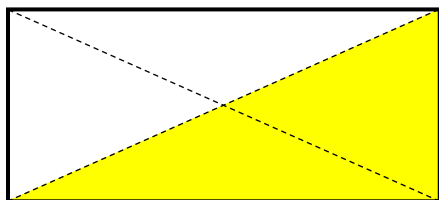
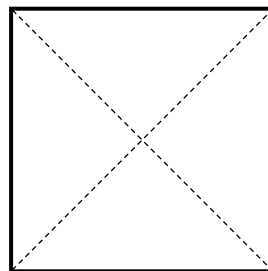
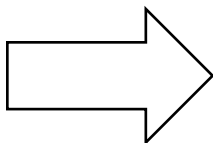
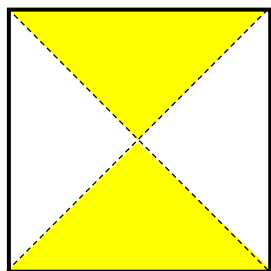

小学 新1年

学習準備シートその2

こたえ

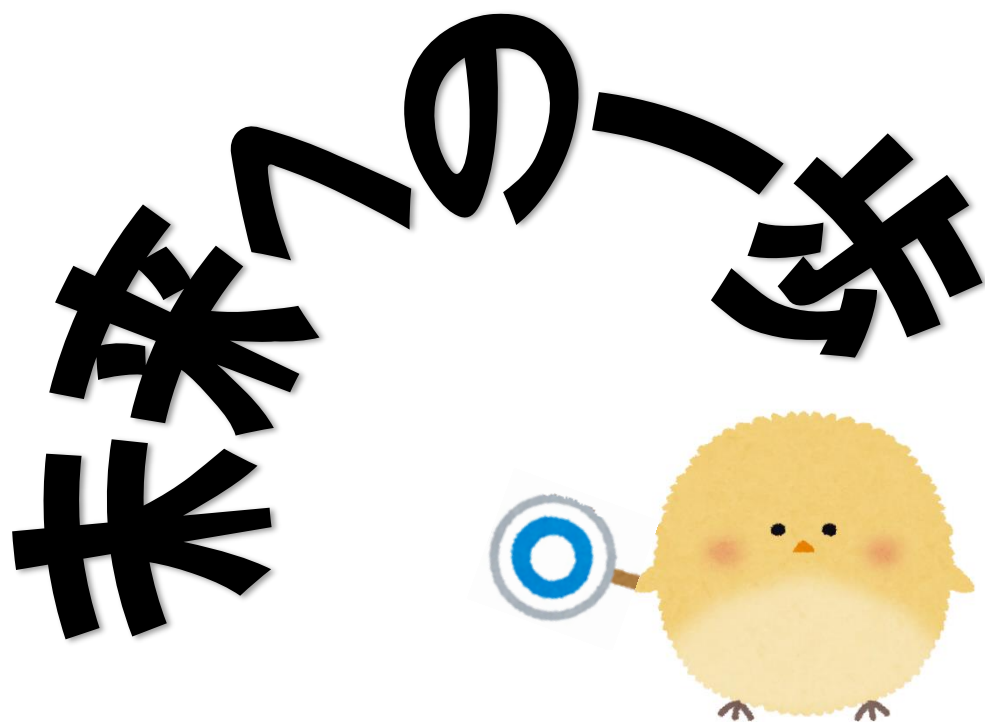

() ねん () くみ () ばん
なまえ ()

1

こえに だしてみよう

◎おうちの ひとなどと いっしょに やってみましょう。

いちねん なまえ

えをみて しつもんに こたえましょう。

(5)	(4)	(3)	(2)	(1)	
					え
<p>おはようございます</p> <p>あさ せんせいに あいさつを しています。 なんと いって いるかな。</p>	<p>なにを しているのかな。</p> <p>とびごを とんでいる、 たいいくを している など</p>	<p>なにを しているのかな。</p> <p>ほんを よんでいる、しらべている など</p>	<p>なんの いきもの かな。</p> <p>とんぼ</p>	<p>なんの どうぶつ かな。</p> <p>くま</p>	しつもん







2

かいて みよう

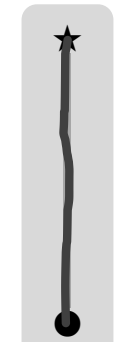
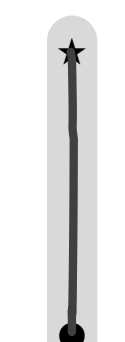
◎おうちのひとなどと いっしょに やってみましょう。

いちねん なまえ

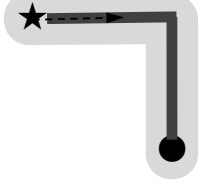
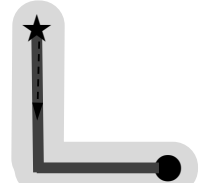
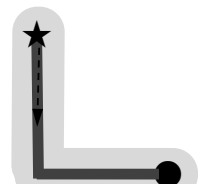
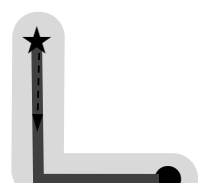
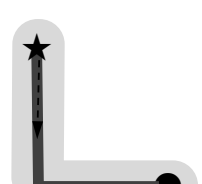
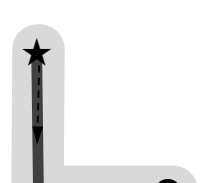
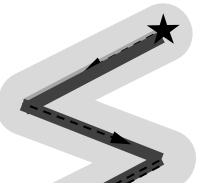
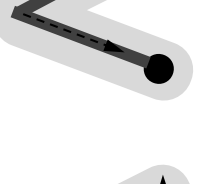
おてほんのように ★から ●に むかって、
 ように かきましよう。 から はみださない

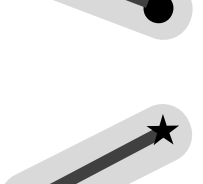
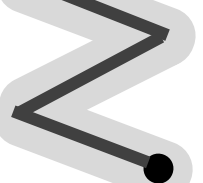
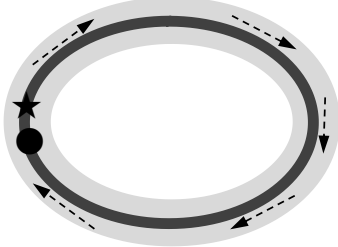
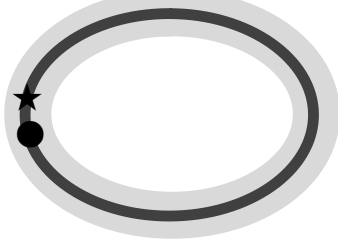
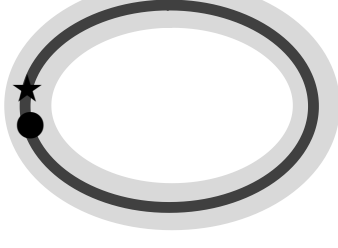
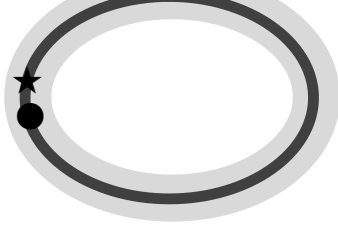
おてほん	(1)	(2)	(3)	(4)
  	    	    	    	   

3



かきくけこを みつけよう

◎おうちの ひとなどと いっしょに やってみましょう。

いちねん なまえ

しつもんに こたえましょう。

しつもん

(5)	(4)	(3)	(2)	(1)	
こ	け	く	き	か	
<p>こではじまる ことばを みつけよう。</p> <p>いくつ みつかる かな。</p> <div style="border: 1px solid black; padding: 5px;"> <p>コップ、こま、こい、子ども など</p> </div>	<p>けではじまる ことばを みつけよう。</p> <p>いくつ みつかる かな。</p> <div style="border: 1px solid black; padding: 5px;"> <p>けんだま、けいと、ケーキ、消しゴム など</p> </div>	<p>くではじまる ことばを みつけよう。</p> <p>いくつ みつかる かな。</p> <div style="border: 1px solid black; padding: 5px;"> <p>くつ、くわがた、くぎ、くり など</p> </div>	<p>きではじまる ことばを みつけよう。</p> <p>いくつ みつかる かな。</p> <div style="border: 1px solid black; padding: 5px;"> <p>きりん、きつね、きつつき、きのこ など</p> </div>	<p>かではじまる ことばを みつけよう。</p> <p>いくつ みつかる かな。</p> <div style="border: 1px solid black; padding: 5px;"> <p>かえる、かぶとむし、かき、かめ など</p> </div>	<p>しつもん</p>
<ul style="list-style-type: none"> •  •  	<ul style="list-style-type: none"> •  •  •  •  	<ul style="list-style-type: none"> •  •  	<ul style="list-style-type: none"> •  •  	<ul style="list-style-type: none"> •  •  	

4

かいて みよう

◎おうちのひとなどと いっしょに やってみましょう。

いちねん なまえ

おてほんをみて ひらがなをかいて みましょう。

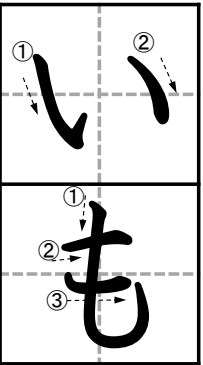
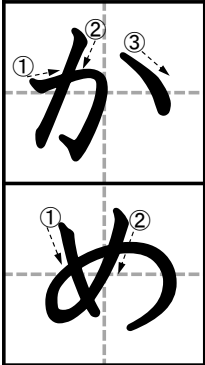
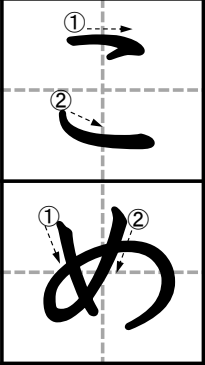
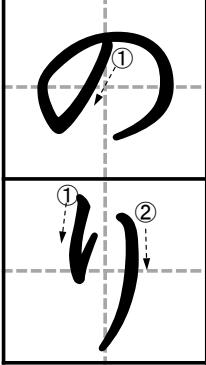
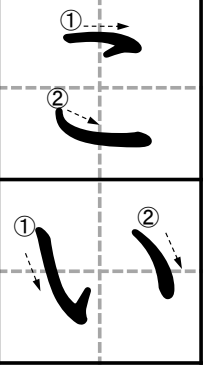
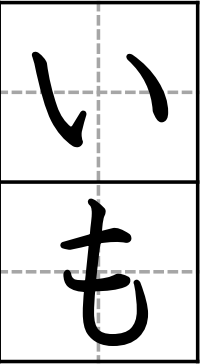
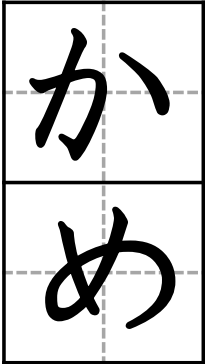
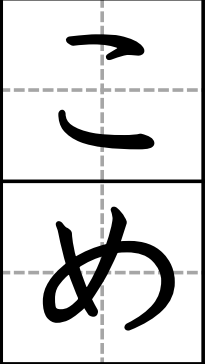
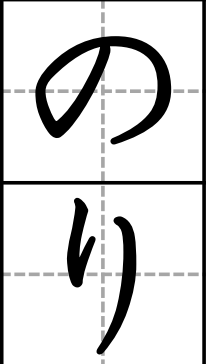
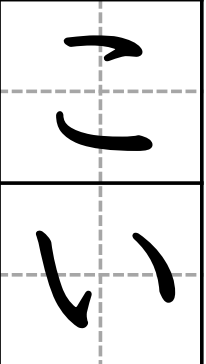
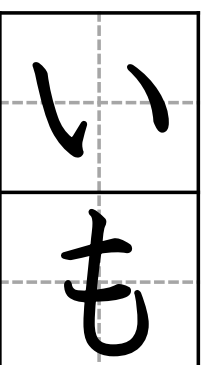
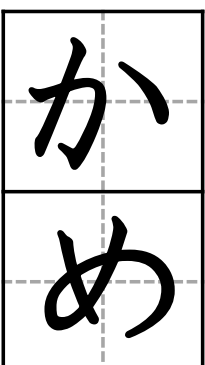
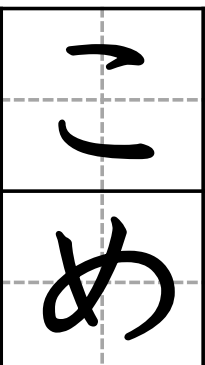
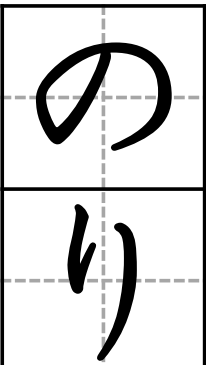
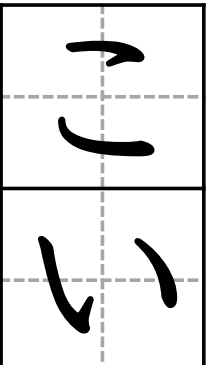
	(5)	(4)	(3)	(2)	(1)	
						おてほん
						なぞりましょう
						かいてみましょう

がくしゅつじゅんびシート ～みらいのいっぽ～

5

じぶんのことを して もらおう
 ◎おうちのひとなどと いっしょに やってみましょう。

いちねん なまえ

おてほんとおなじように じぶんのことを はなして みましょう。

おてほん

はなして みましょう

わたしの なまえは
 ふくおか みらい です。



わたし(ぼく)の なまえは

※本人の名前

です。

すきな たべものは
 いちご です。



すきな たべものは

※本人が好きな食べ物

です。

すきな どうぶつは
 いぬ です。



すきな どうぶつは

※本人が好きな動物

です。

すきな あそびは
 おにごっこ です。



すきな あそびは

※本人が好きな遊び

です。

はる なつ あき ふゆの
 なかで すきな きせつは
 なつです。



はる なつ あき ふゆの

なかで すきな きせつは

※本人が好きな季節

です。

6

さしすせそを みつけよう

◎おうちのひとなどと いっしょに やってみましょう。

いちねん なまえ

しつもん に こたえましょう。

しつもん

(5)	(4)	(3)	(2)	(1)	
そ	せ	す	し	さ	
<p>そで はじまる ことばを みつけよう。</p> <p>いくつ みつかる かな。</p> <div style="border: 1px solid black; padding: 5px;"> <p>そうじき、ソリ、 そうこ、ソフトクリーム など</p> </div>	<p>せで はじまる ことばを みつけよう。</p> <p>いくつ みつかる かな。</p> <div style="border: 1px solid black; padding: 5px;"> <p>せんべい、セミ、 先生、せっけん など</p> </div>	<p>すで はじまる ことばを みつけよう。</p> <p>いくつ みつかる かな。</p> <div style="border: 1px solid black; padding: 5px;"> <p>すもう、スイカ、 すし、スケート など</p> </div>	<p>しで はじまる ことばを みつけよう。</p> <p>いくつ みつかる かな。</p> <div style="border: 1px solid black; padding: 5px;"> <p>しんぶん、しか、 シマウマ、シャツ など</p> </div>	<p>さで はじまる ことばを みつけよう。</p> <p>いくつ みつかる かな。</p> <div style="border: 1px solid black; padding: 5px;"> <p>さら、さかな、 さとう、さか など</p> </div>	
<p>・</p> <p>・</p> <p>・</p> 	<p>・</p> <p>・</p> <p>・</p> 	<p>・</p> <p>・</p> <p>・</p> 	<p>・</p> <p>・</p> <p>・</p> 	<p>・</p> <p>・</p> <p>・</p> 	

7

かいて みよう

◎おうちのひとなどと いっしょに やってみましょう。

いちねん なまえ

おてほんをみて ひらがなをかいて みましょう。

(5)	(4)	(3)	(2)	(1)	
					おてほん
					なぞりましょう
					かいてみましょう

8

たちつてとき みつけよう

◎おうちのひとなどと いっしょに やってみましょう。

いちねん なまえ

しつもん に こたえましょう。

(5)	(4)	(3)	(2)	(1)	
と	て	つ	ち	た	
<p>とではじまることばを みつけよう。</p> <p>いくつ みつかる かな。</p> <div style="border: 1px solid black; padding: 5px;"> <p>時計、トマト、 トンボ、トカゲ など</p> </div>	<p>てではじまることばを みつけよう。</p> <p>いくつ みつかる かな。</p> <div style="border: 1px solid black; padding: 5px;"> <p>手袋、テントウムシ、 テント、天気 など</p> </div>	<p>つではじまることばを みつけよう。</p> <p>いくつ みつかる かな。</p> <div style="border: 1px solid black; padding: 5px;"> <p>つくえ、つみき、 つえ、月 など</p> </div>	<p>ちではじまることばを みつけよう。</p> <p>いくつ みつかる かな。</p> <div style="border: 1px solid black; padding: 5px;"> <p>チョコレート、ちず、 チーズ、チーム など</p> </div>	<p>たではじまることばを みつけよう。</p> <p>いくつ みつかる かな。</p> <div style="border: 1px solid black; padding: 5px;"> <p>たこ、たぬき、 たんぽぽ、たいこ など</p> </div>	しつもん
<ul style="list-style-type: none"> •  •  • 	<ul style="list-style-type: none"> •  •  • 	<ul style="list-style-type: none"> •  •  • 	<ul style="list-style-type: none"> •  •  • 	<ul style="list-style-type: none"> •  •  • 	

9

かいて みよう

◎おうちのひとなどと いっしょに やってみましよう。

いちねん なまえ





おてほんをみて ひらがなをかいて みましよう。

(5)	(4)	(3)	(2)	(1)	
					おてほん
					なぞりましよう
					かいてみましよう

こんなとき なんて いおうかな
 ◎おうちの ひとなどと いっしょに やってみましょう。

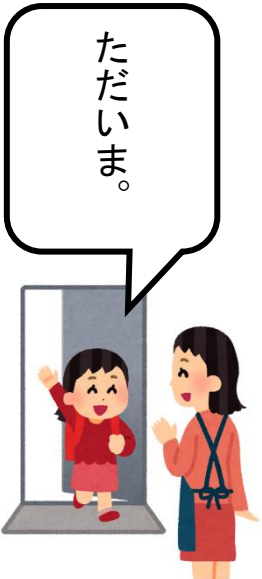
いちねん なまえ

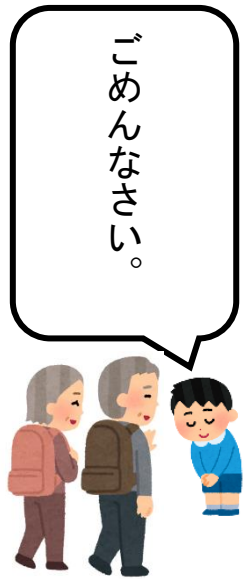
こんなとき なんと いえば よいか かんがえて はなして みましょう。

	なんと いえば よいかな
(1) おうちに かえって きたとき	ただいま。 
(2) おれいを いうとき	ありがとう ごぎいます。 
(3) あやまるとき	ごめんなさい。 
(4) おひるに あいさつ するとき	こんにちは。 
(5) ともだちが こまっているとき	だいじょうぶ。 どうしたの。 

I なかまさがし

いちねん なまえ

◎おうちの ひとなどと いっしょに やってみましょう。

おなじ なかまを せんで かこもう

れい

りんご

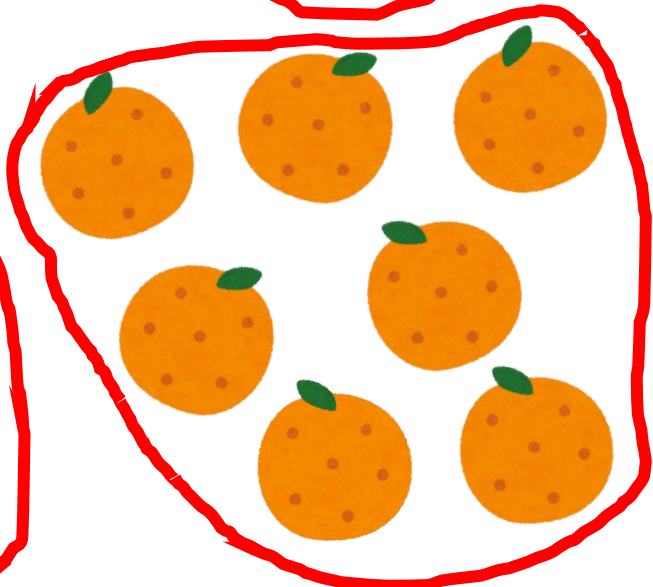
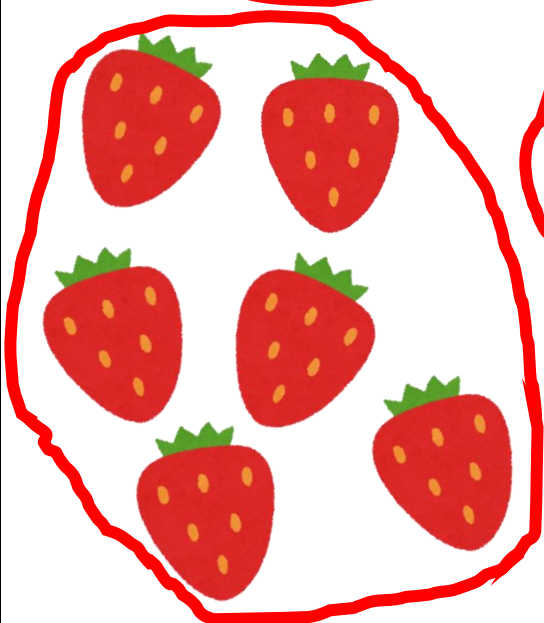
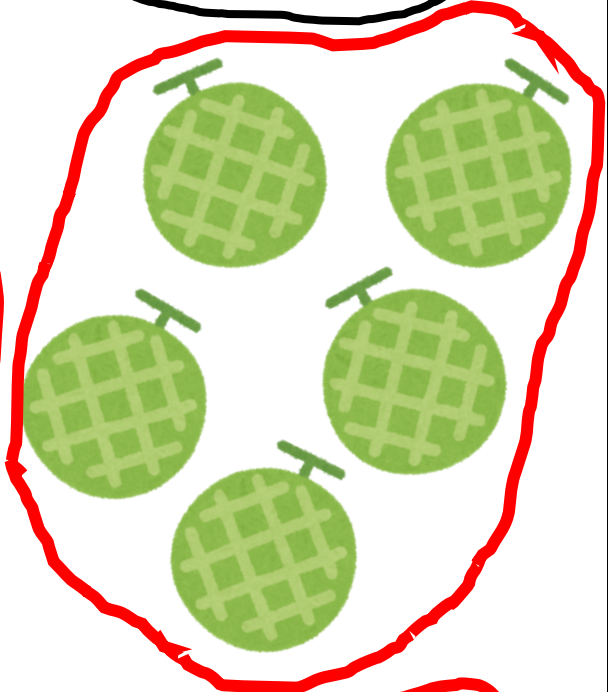
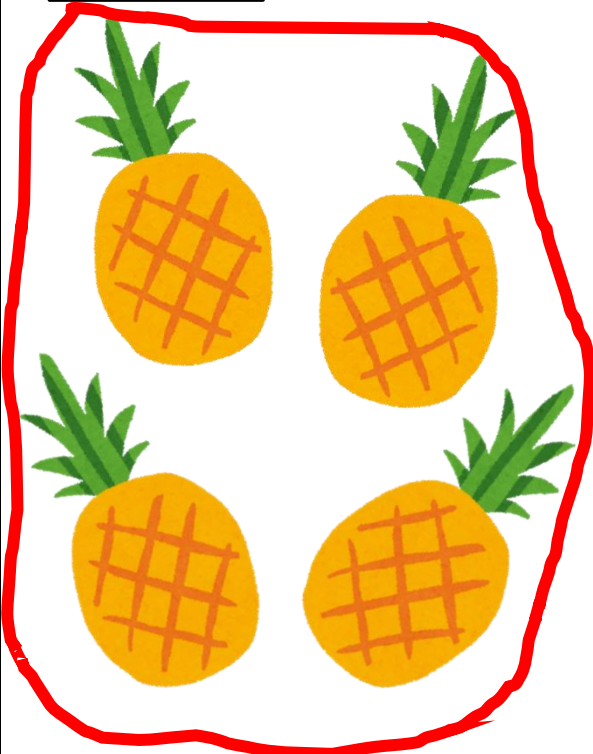
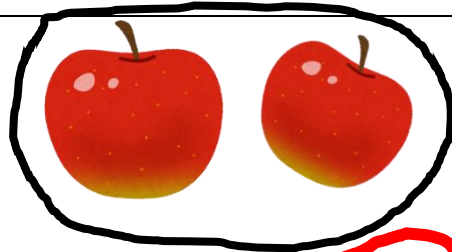

がくしゅう じゅんぴ シート ~みらいへの いっぽ~

II どちらが ながい

いちねん なまえ

◎おうちの ひとなどと いっしょに やってみましょう。

どちらが おおいかな

せんで むすぼう

れい

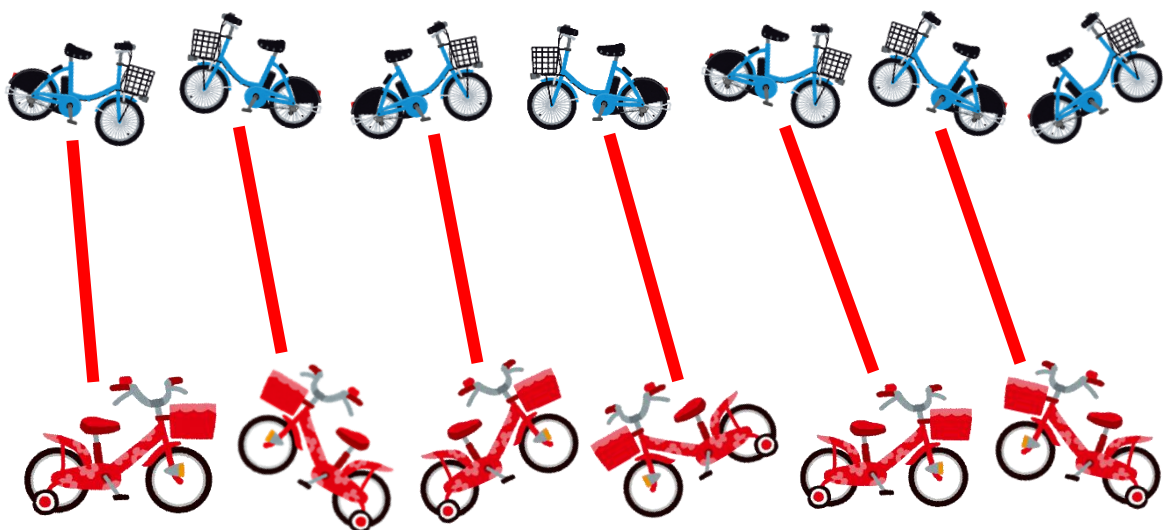
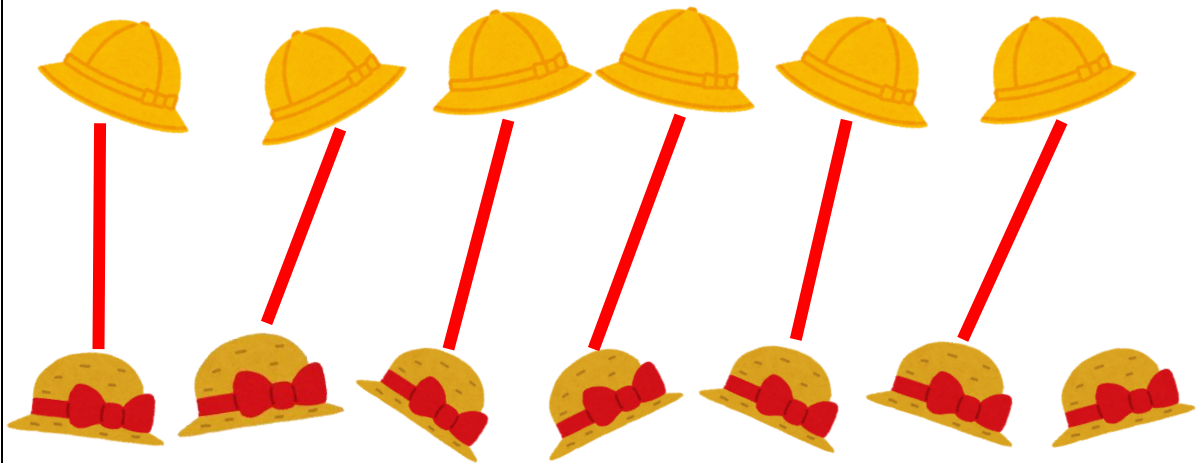
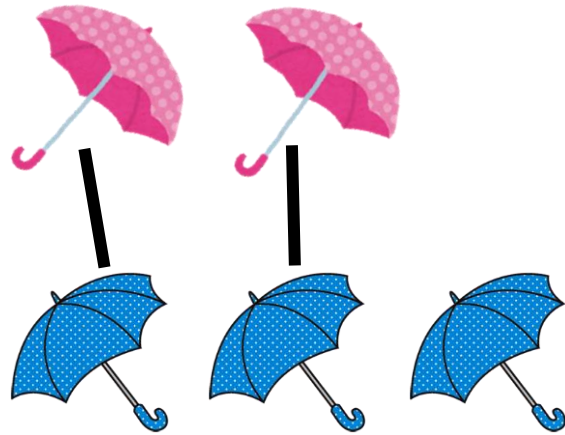

Ⅲ おなじ かず

いちねん なまえ

◎おうちの ひとなどと いっしょに やってみましょう。

おなじ かずだけ いろを ぬろう

れい

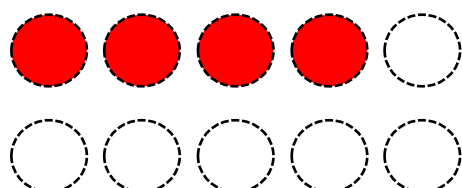
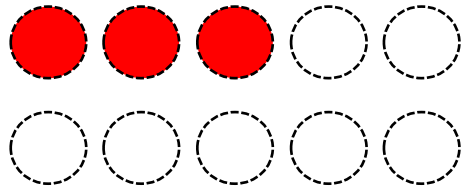
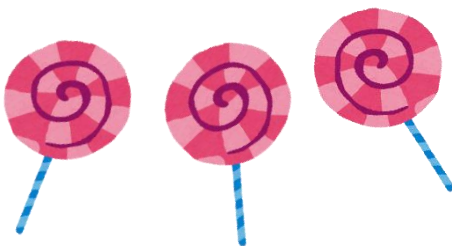
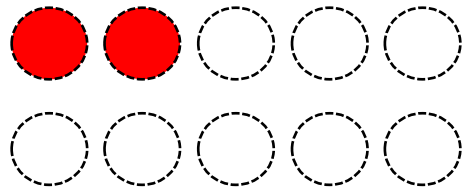
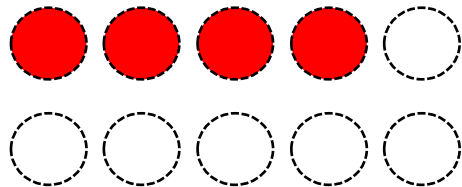
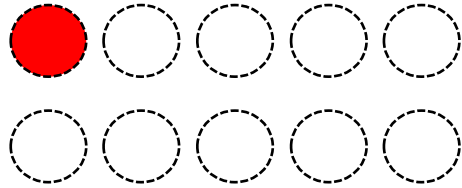

Ⅲ おなじ かず

いちねん なまえ

◎おうちの ひとなどと いっしょに やってみましょう。

おなじ かずだけ いろを ぬろう

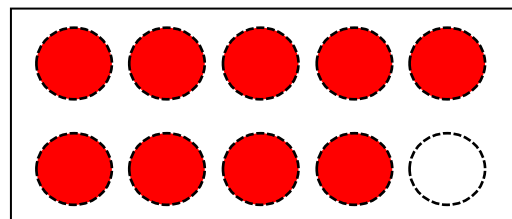
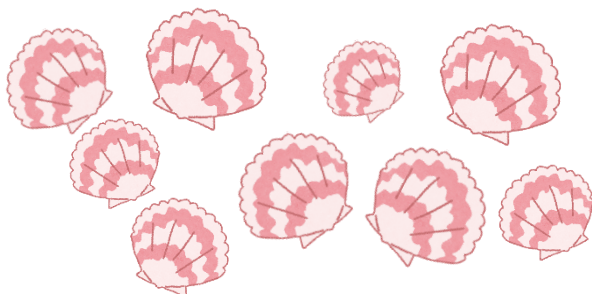
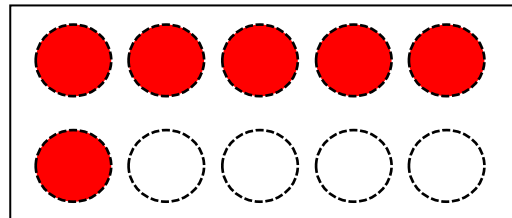
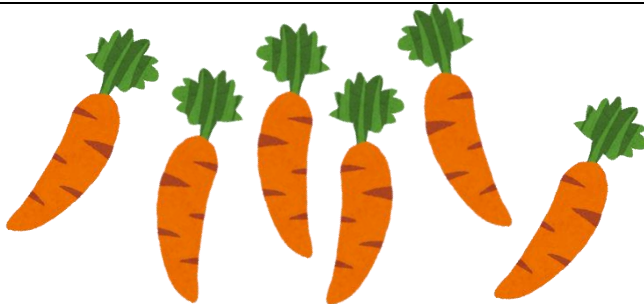
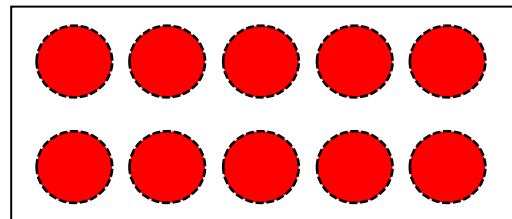
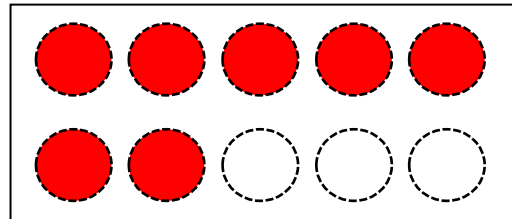
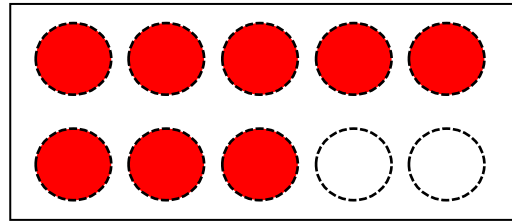
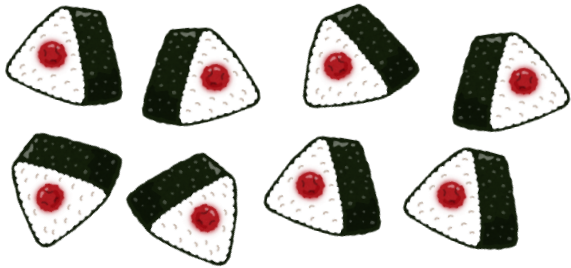

がくしゅう じゅんぴ シート ~みらいへの いっぽ~

IV おなじ ばしょ

いちねん なまえ

◎おうちの ひとなどと いっしょに やってみましょう。

おなじ ばしょに いろを ぬろう

れい

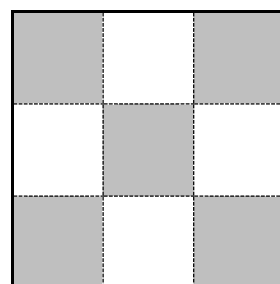
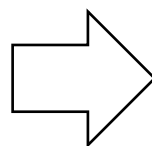
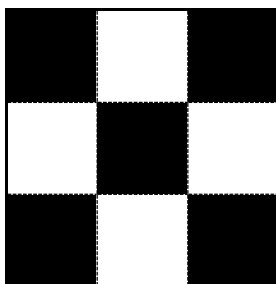
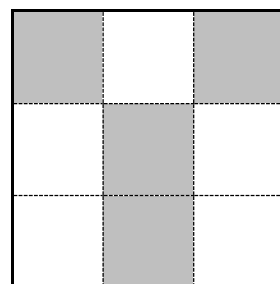
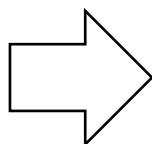
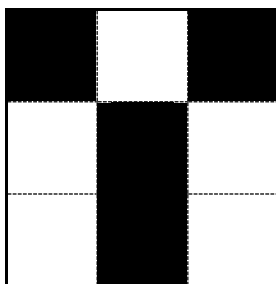
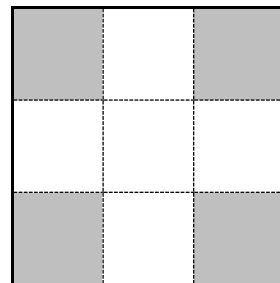
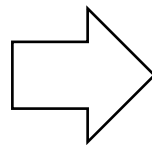
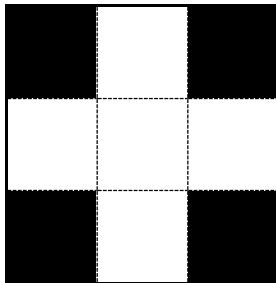
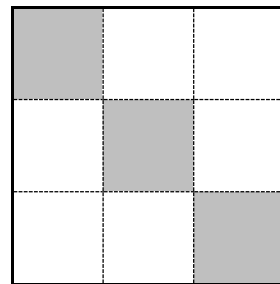
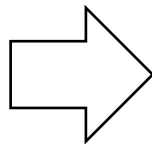
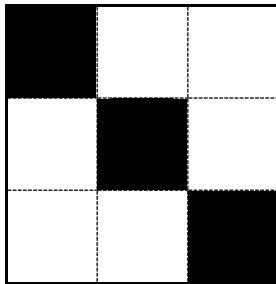
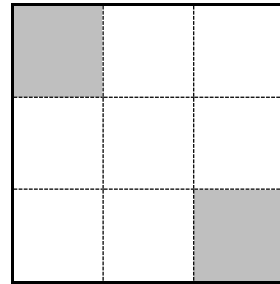
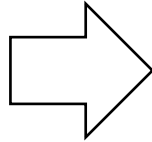
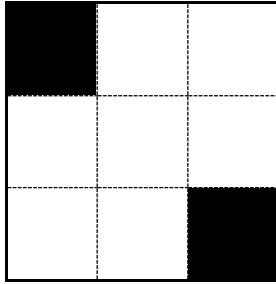

がくしゅう じゅんぴ シート ~みらいへの いっぽ~

V おなじ かたち

いちねん なまえ

◎おうちの ひとなどと いっしょに やってみましょう。

おなじ かたちを さがそう

れい

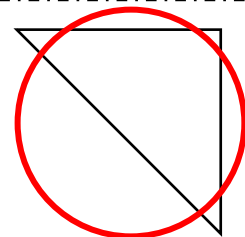
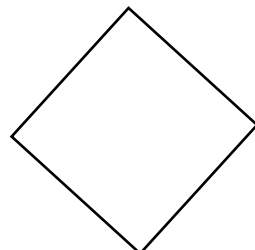
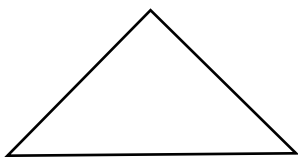
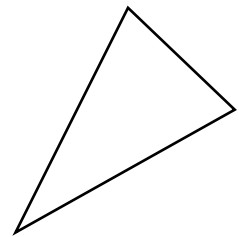
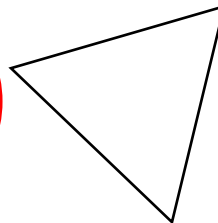
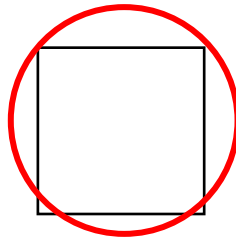
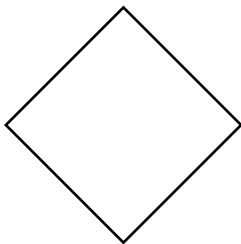
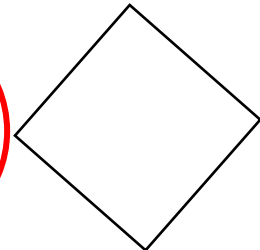
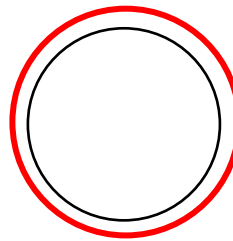
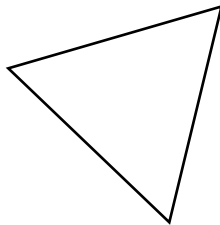
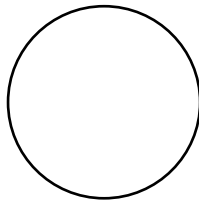
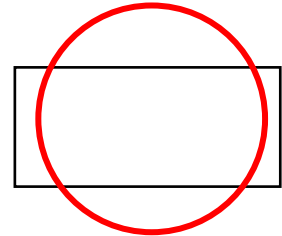
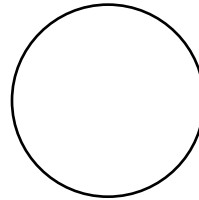
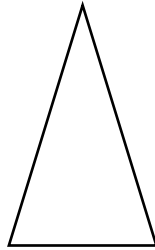
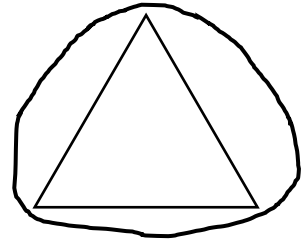
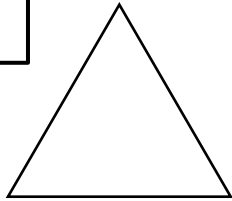

がくしゅう じゅんぴ シート ~みらいへの いっぽ~

I おなじ かず

いちねん なまえ

◎おうちの ひとなどと いっしょに やってみましょう。

おなじ かず どうしを せんで むすぼう

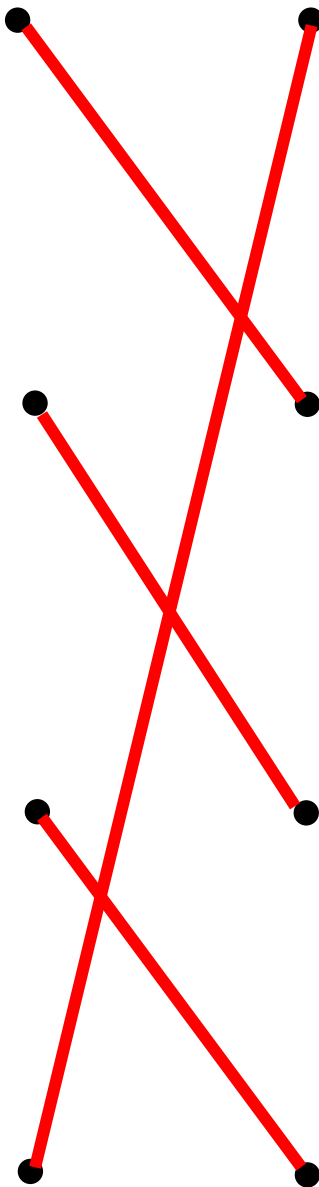
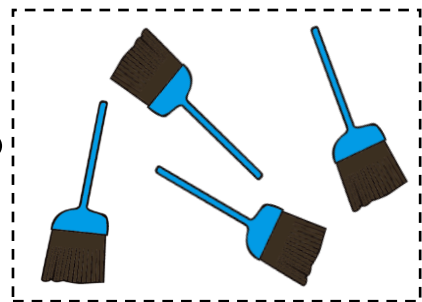
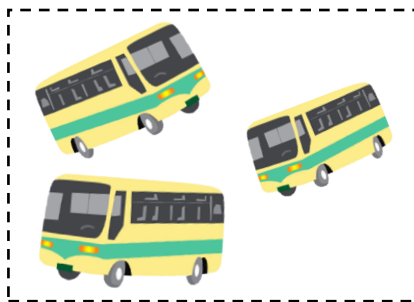
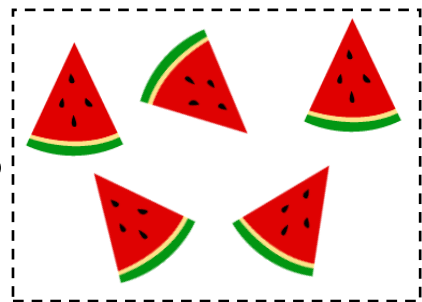
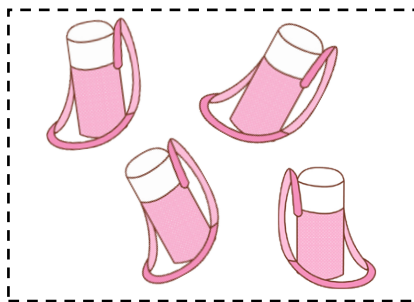
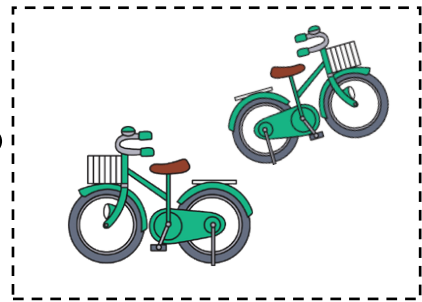
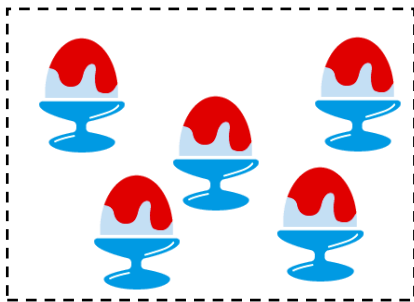
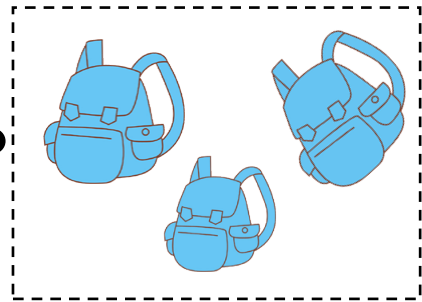
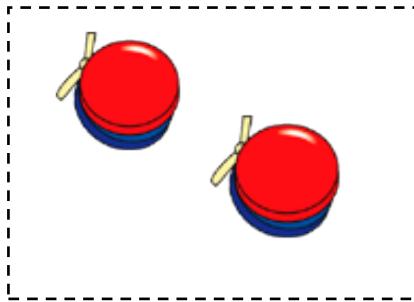

II おなじ かず

いちねん なまえ

◎おうちの ひとなどと いっしょに やってみましょう。

おなじ かず どうしを せんで むすぼう

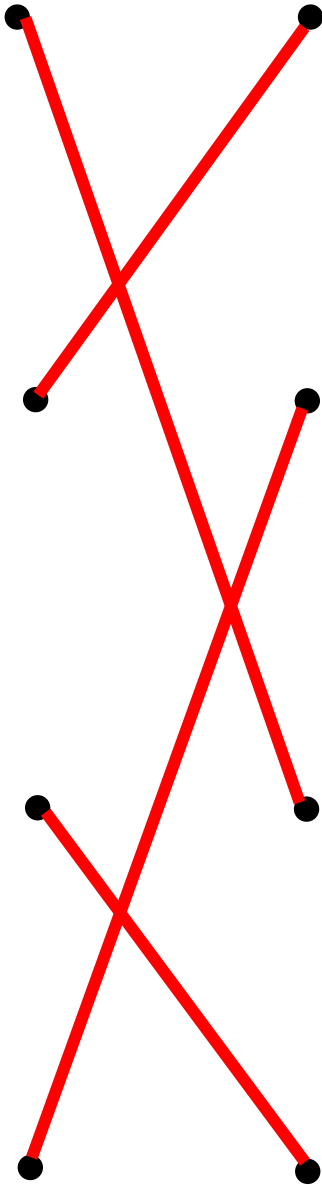
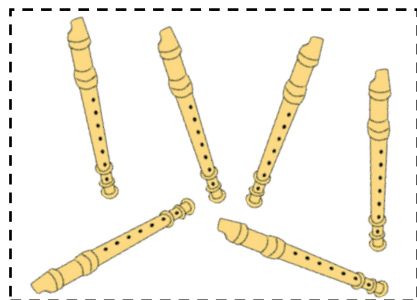
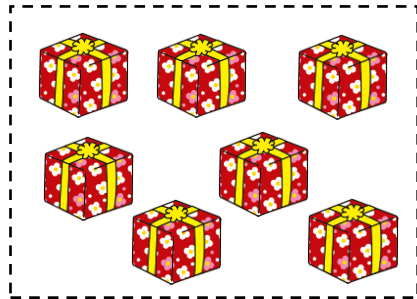
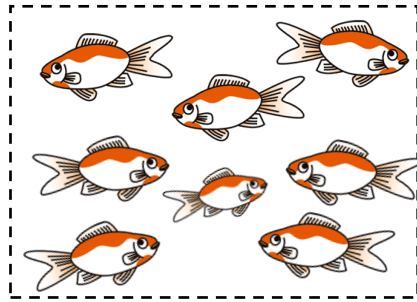
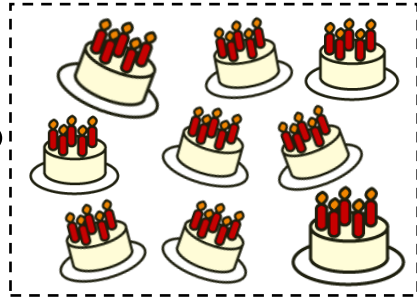
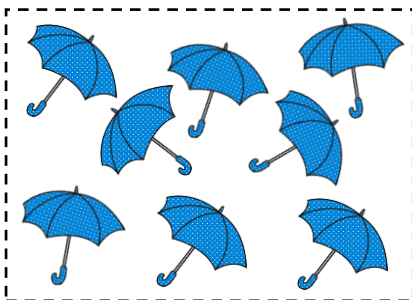
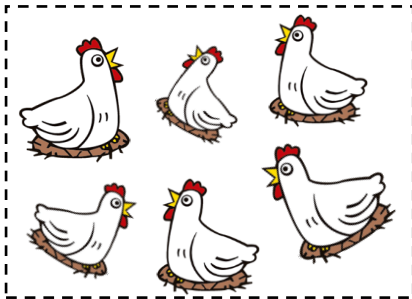

Ⅲ 10までの かず

いちねん なまえ

◎おうちの ひとなどと いっしょに やってみましょう。

すうじを よんで かいてみよう

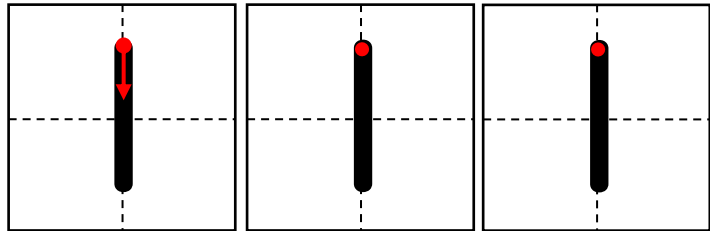
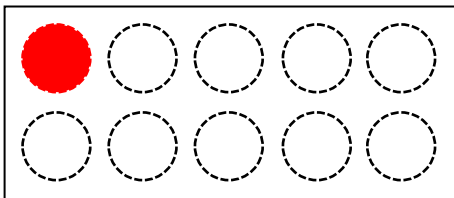

いち

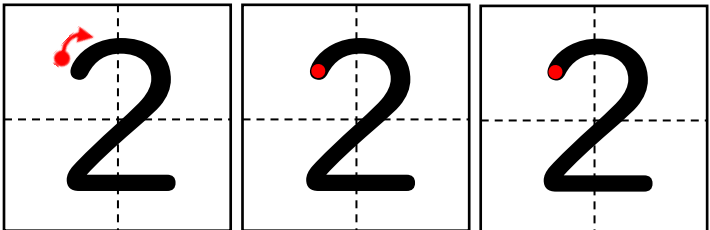
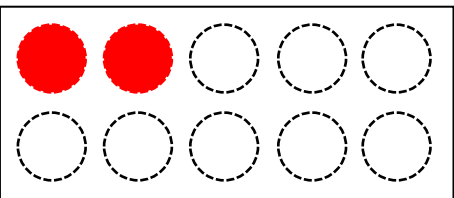

に

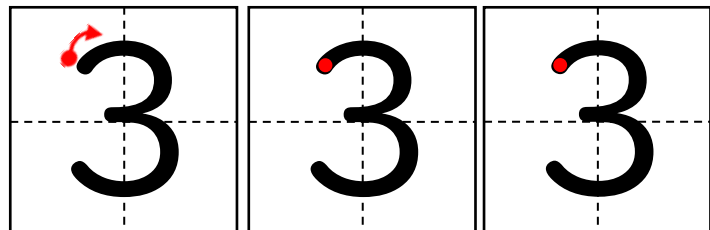
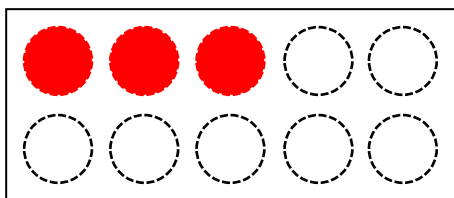

さん

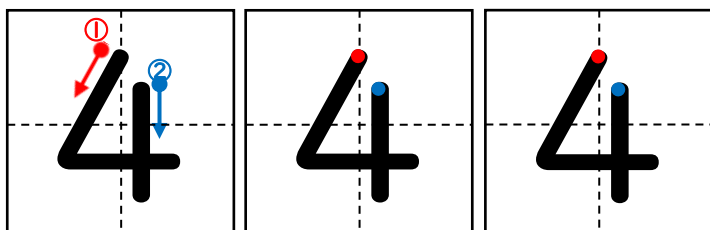
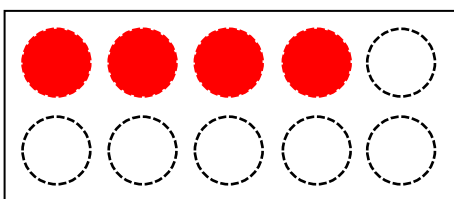

し

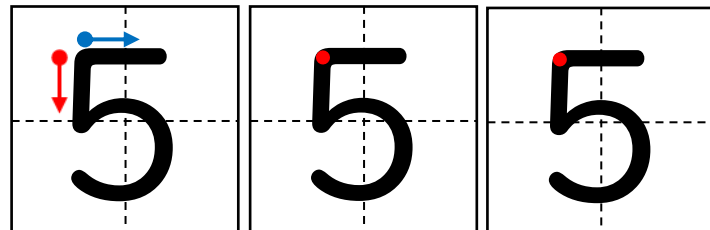
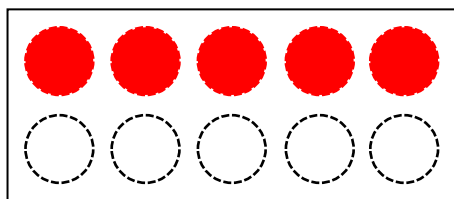

ご

IV 10までの かず

いちねん なまえ

◎おうちの ひとなどと いっしょに やってみましょう。

すうじを よんで かいてみよう

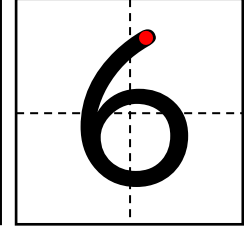
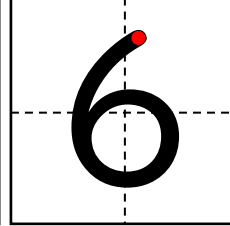
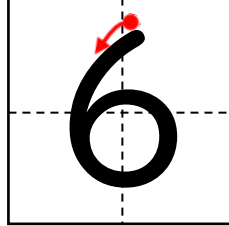
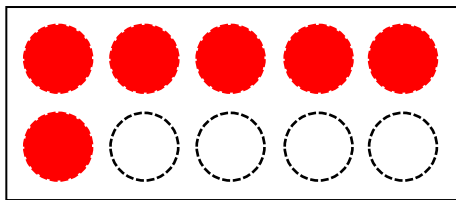

ろく

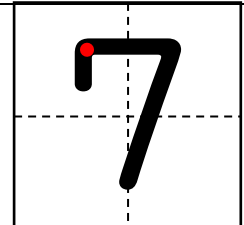
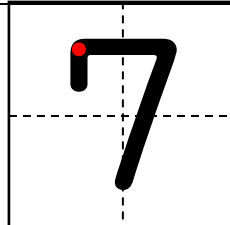
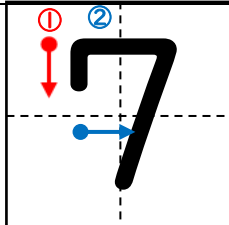
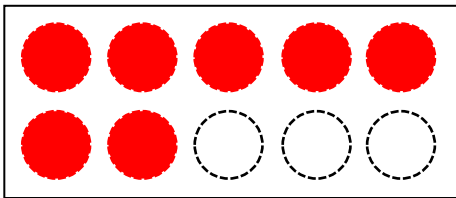

しち(なな)

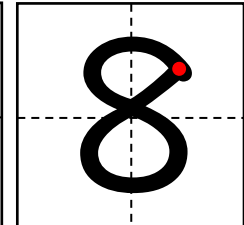
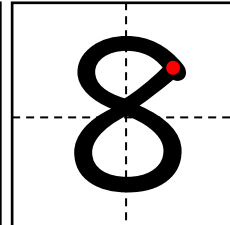
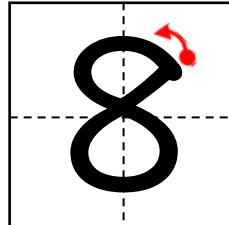
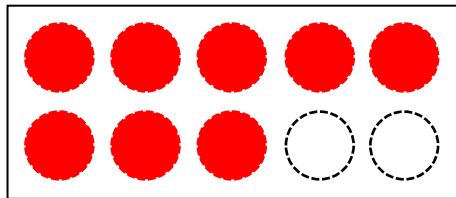

はち

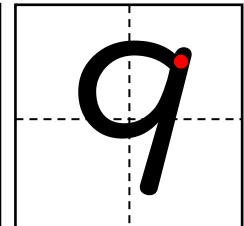
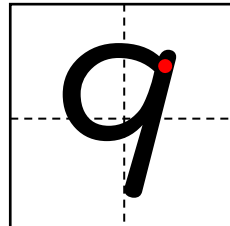
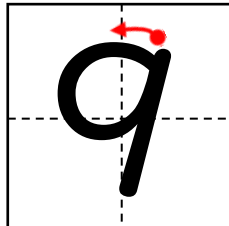
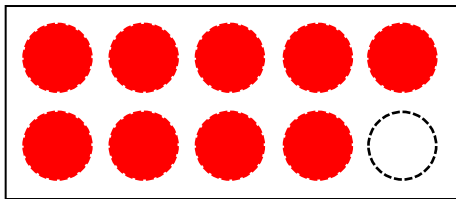

く(きゅう)

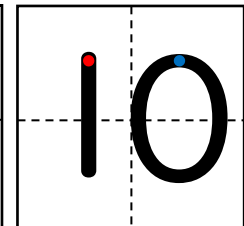
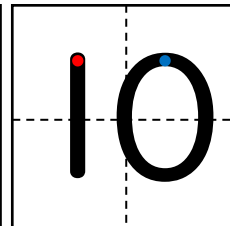
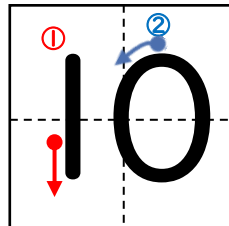
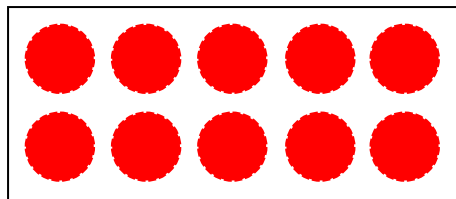

じゅう

がくしゅう じゅんぴ シート ~みらいへの いっぽ~

V おなじ ばしょ

いちねん なまえ

◎おうちの ひとなどと いっしょに やってみましょう。

おなじ ばしょに いろを ぬろう

